

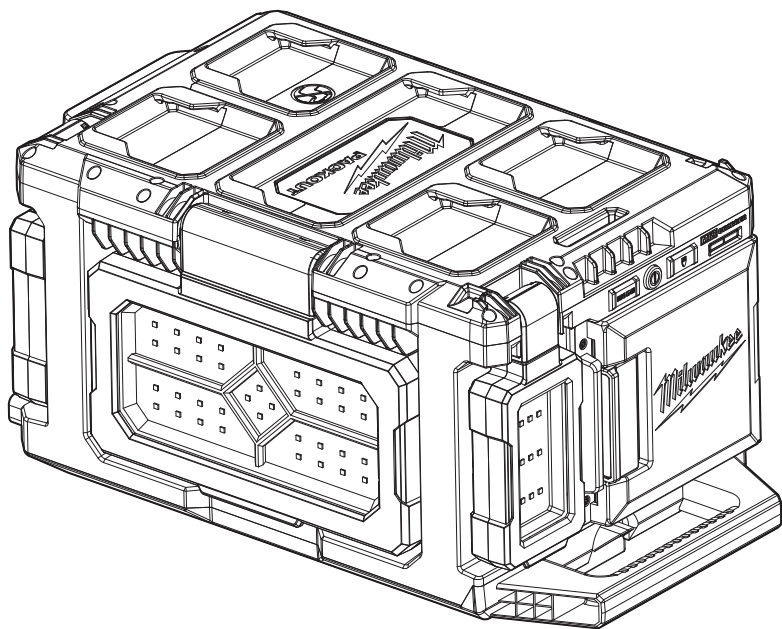

OPERATOR'S MANUAL



Cat. No.
M18 POALC

M18™ PACKOUT™ AREA LIGHT/CHARGER



WARNING

To reduce the risk of injury, user must read and understand operator's manual.

IMPORTANT SAFETY INSTRUCTIONS

⚠WARNING Read all safety warnings and all instructions. Failure to follow the warnings and instructions may result in electric shock, fire and/or serious injury. **Save all warnings and instructions for future reference.**

- This appliance is not intended to be used or cleaned by persons with reduced physical, sensory or mental capabilities, or lack of experience or knowledge, unless they have been given instructions concerning the safe use of the appliance by a person legally responsible for their safety. They should be supervised whilst using the appliance.
- Children shall not use, clean or play with this appliance, which when not in use should be secured out of their reach.

WORK AREA SAFETY

- **To reduce the risk of injury, close supervision is necessary** when an appliance is used near children.
- **Store idle light out of reach of children.** Warm lights can become hazardous in the hands of children.
- **Do not expose to rain. Store indoors.**

ELECTRICAL SAFETY

- **Power cord plugs must match the outlet. Never modify the plug in any way. Do not use any adapter plugs with earthed (grounded) power tools.** Unmodified plugs and matching outlets will reduce risk of electric shock.
- **Avoid body contact with earthed or grounded surfaces, such as pipes, radiators, ranges and refrigerators.** There is an increased risk of electric shock if your body is earthed or grounded.
- **To reduce the risk of electric shock, do not put light in water or other liquid.** Do not place or store appliance where it can fall or be pulled into a tub or sink.
- **Do not abuse the cord. Never use the cord for carrying, pulling or unplugging the product. Keep cord away from heat, oil, sharp edges or moving parts.** Damaged or entangled cords increase the risk of electric shock.
- **Arrange cords carefully to avoid hazardous environments.** Tripping or snagging on cords can cause injury and product damage. Do not allow cords to run through puddles or across wet ground.
- **Do not unplug by pulling on the cord.** To unplug, grasp the plug, not the cord.
- **Unplug the cord from outlet when not in use and before servicing or cleaning.**
- **Always use a suitable extension cord to reduce the risk of electric shock.**
- **When operating a light outdoors, use an extension cord suitable for outdoor use.** Use of a cord suitable for outdoor use reduces the risk of electric shock.
- **If operating a light in a damp location is unavoidable, use a residual current device (RCD) protected supply.** Use of a RCD reduces the risk of electric shock.

PERSONAL SAFETY

- **Do not overreach. Keep proper footing and balance at all times.** This enables better control of the unit in unexpected situations.
- **Do not use on a ladder or unstable support.** Loose Stable footing on a solid surface enables better control of the light in unexpected situations.
- **Do not stare at the operating light source.**

- **To reduce the risk of fire or burns, keep hands and combustible materials away from lens.** Lens may become hot after extended use.

BATTERY TOOL USE AND CARE

- **Recharge only with the charger specified by the manufacturer.** A charger that is suitable for one type of battery pack may create a risk of fire when used with another battery pack.
- **Use light only with specifically designated battery packs.** Use of any other battery packs may create a risk of injury and fire.
- **When battery pack is not in use, keep it away from other metal objects, like paper clips, coins, keys, nails, screws or other small metal objects, that can make a connection from one terminal to another.** Shorting the battery terminals together may cause burns or a fire.
- **Do not short circuit.** A short-circuited battery pack may cause fire, personal injury, and product damage. A battery pack will short circuit if a metal object makes a connection between the positive and negative contacts on the battery pack. Do not place a battery pack near anything that may cause a short circuit, such as coins, keys or nails in your pocket.
- **Do not allow fluids to flow into battery pack.** Corrosive or conductive fluids, such as seawater, certain industrial chemicals, and bleach or products containing bleach.
- **Under abusive conditions, liquid may be ejected from the battery; avoid contact. If contact accidentally occurs, flush with water. If liquid contacts eyes, additionally seek medical help.** Liquid ejected from the battery may cause irritation or burns.
- **Do not use a battery pack or tool that is damaged or modified.** Damaged or modified batteries may exhibit unpredictable behaviour resulting in fire, explosion or risk of injury.
- **Do not expose a battery pack or tool to fire or excessive temperature.** Exposure to fire or temperature above 130°C (265°F) may cause explosion.
- **Follow all charging instructions and do not charge the battery pack or tool outside the temperature range specified in the instructions.** Charging improperly or at temperatures outside the specified range may damage the battery and increase the risk of fire.

CHARGER USE AND CARE

- **⚠CAUTION** To reduce the risk of injury, charge **MILWAUKEE®** Lithium-Ion packs only in their **MILWAUKEE®** Lithium-Ion charger. Other types of batteries may burst causing personal injury and damage. Do not wire a battery pack to a power supply plug or car cigarette lighter. Batteries will be permanently disabled or damaged.
- **Charge only MILWAUKEE® M18™ Lithium-Ion packs.** Other types of batteries may burst causing personal injury or damage.
- **Avoid dangerous environments.** Do not charge battery pack in rain, snow, damp or wet locations. Do not use battery pack or charger in the presence of explosive atmospheres (gaseous fumes, dust or flammable materials) because sparks may be generated when inserting or removing battery pack, possibly causing fire.
- **Charge in a well ventilated area.** Do not allow smoking or open flames near a charging battery pack. Vented gases may explode.

• **Maintain charger cord.** When unplugging charger, pull plug rather than cord to reduce the risk of damage to the electrical plug and cord. Never carry charger by its cord. Keep cord from heat, oil and sharp edges. Make sure cord will not be stepped on, tripped over or subjected to damage or stress. Do not use charger with damaged cord or plug. Have a damaged charger replaced immediately.

• If the external flexible cable or cord of the product is damaged, it shall be exclusively replaced by the manufacturer.

• **Use only recommended attachments.** Use of an attachment not recommended or sold by the battery charger or battery pack manufacturer may result in a risk of fire, electric shock or personal injury.

• **Unplug charger** when not in use. Remove battery packs from unplugged chargers.

• **To reduce the risk of electric shock,** always unplug charger before cleaning or maintenance. Do not allow water to flow into AC/DC plug. Use a residual current device (RCD) to reduce shock hazards.

• **Store your battery and charger** in a cool, dry place. Do not store battery pack where temperatures may exceed 50°C (120°F) such as in direct sunlight, a vehicle or metal building during the summer.

SERVICE

• **Have your light serviced by a qualified repair person using only identical replacement parts.** This will ensure that the safety of the light is maintained.

• **Never service damaged battery packs.** Service of battery packs should only be performed by the manufacturer or authorised service providers.

SPECIFIC SAFETY RULES FOR LIGHTS

⚠WARNING The lens may get hot during use. To reduce the risk of burns, do not touch hot lens.

• **Always use common sense and be cautious when using the product.** It is not possible to anticipate every situation that could result in a dangerous outcome. Do not use this product if you do not understand these operating instructions or you feel the work is beyond your capability; contact **MILWAUKEE®** Tool or a trained professional for additional information or training.

• **Maintain labels and nameplates.** These carry important information. If unreadable or missing, contact a **MILWAUKEE®** service facility for a replacement.

• The light source contained in the product shall only be replaced by the manufacturer, its service agent or a similar qualified person.

SAVE THESE INSTRUCTIONS

ADDITIONAL BATTERY SAFETY RULES

⚠WARNING To reduce the risk of fire, personal injury, and product damage due to a short circuit, never immerse your tool, battery pack or charger in fluid or allow a fluid to flow inside them. Corrosive or conductive fluids, such as seawater, certain industrial chemicals, and bleach or bleach-containing products, etc., can cause a short circuit.

⚠WARNING Do not charge non-rechargeable batteries.

SPECIFICATIONS

Cat. No.	M18 POALC
DC Input Volts.....	18V
DC Output Volts.....	18V
DC Output Power.....	45W
AC Input Volts.....	220-240V
Frequency.....	50-60Hz
AC Input Power.....	130W
Output Volts USB.....	5V
Output Amps USB.....	2.1A
Operating Temperature	
Battery and Charger.....	0°C to 65°C (32°F to 150°F)
Battery and Tool.....	-20°C to 40°C (-4°F to 104°F)
IP rating.....	IP54
M18™ Li-Ion Battery Packs	18V DC



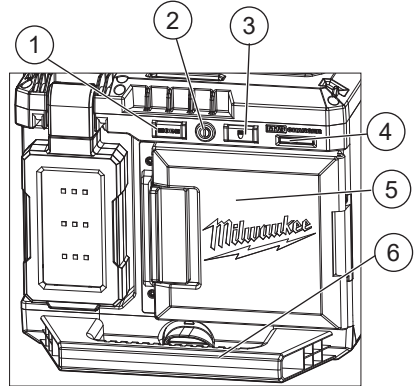



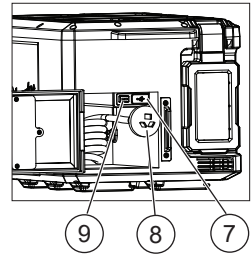







FUNCTIONAL DESCRIPTION



1. MODE button
2. Power button
3. Brightness button
4. Charger indicators
5. Battery bay
6. Handle
7. USB Outlet
8. Power plug
9. USB power button

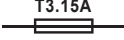

SYMBOLOLOGY

	Volts
	Direct Current
	Alternating Current
	Amps
	Hertz
	Do not stare at the operating light source.
	Double insulated
	Do not step or stand.
	AC Power
	Universal serial bus (USB)
	USB power button
	T3.15A Time lag fuse
	Read operator's manual
	Do not dispose of electric tools together with household waste material. Electric tools and electronic equipment that have reached the end of their life must be collected separately and returned to an environmentally compatible recycling facility.
	Regulatory Compliance Mark (RCM). This product meets applicable regulatory requirements.

ASSEMBLY

⚠WARNING Recharge only with the charger specified for the battery. For specific charging instructions, read the operator's manual supplied with your charger and battery.

Removing/Inserting the Battery

To remove the battery, push in the release buttons and pull the battery pack away from the tool.

⚠WARNING Always remove battery pack before changing or removing accessories.



To insert the battery, slide the pack into the body of the tool. Make sure it latches securely into place.

⚠WARNING Only use accessories specifically recommended for this tool. Others may be hazardous.

OPERATION

⚠CAUTION To reduce the risk of injury, do not stare at the operating light source.

Using the Lights

1. Insert battery pack or connect to AC power.
2. Press the power  button to turn on the light.
3. Press the brightness  button to cycle through High, Medium, and Low.
4. Press the MODE button to select full lighting, main light, or front/back lights.
5. Press the power  button to turn OFF the light.

NOTE: The light will default to the selected brightness and selected mode setting the next time it is turned on. On battery power, the light will flash to indicate the battery is reaching end-of-charge.

Rotating the Lights

To rotate the main light, pull the light outward and rotate up to 210° counterclockwise or 95° clockwise. To rotate the front and back lights, pull the lights outward and rotate up to 30° counterclockwise or 300° clockwise.

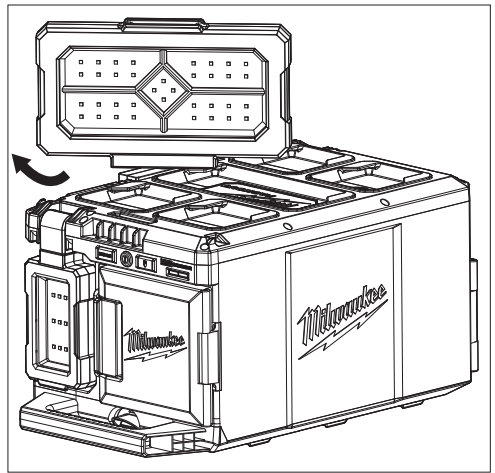

USB Power Outlet

This outlet can be used to charge a cell phone, power an MP3 player or any other device that uses less than 2.1A of DC electrical current. To turn on the USB, press the USB power  button. The USB port will remain on for two hours before turning off automatically.

NOTE: Any device that uses more than 2.4A of DC electrical current will trip a self-resetting overload and disable the output.

BATTERY OPERATION

Fuel Gauge

Use the Fuel Gauge on the battery pack to determine the battery pack's remaining run time. Press the Fuel Gauge button to display the lights. The Fuel Gauge will light up for 2-3 seconds. When less than 10% of charge is left, 1 light on the fuel gauge will flash slowly.

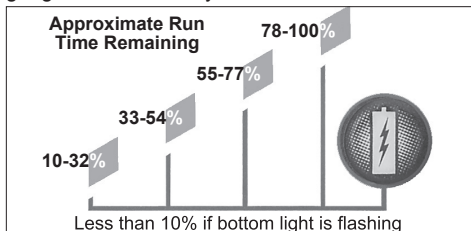

NOTE: If the Fuel Gauge doesn't appear to be working, place the battery pack on the charger and charge as needed.

Compared to NiCd battery pack types, MILWAUKEE® Lithium-Ion battery packs deliver fade-free power for their entire run time. The tool will not experience a slow, gradual loss of power as you work. To signal the end of discharge, 1 light on the fuel gauge will flash quickly for 2-3 seconds and the tool will not run. Charge the battery pack.

NOTE: Immediately after using the battery pack, the Fuel Gauge may display a lower charge than it will if checked a few minutes later. The battery cells "recover" some of their charge after resting.

Battery Pack Protection

To protect itself from damage and extend its life, the battery pack's intelligent circuit monitors current draw and temperature. In extremely high torque, binding, stalling, and short circuit situations, the battery pack will turn OFF the tool if the current draw becomes too high. All the fuel gauge lights will flash. Release the trigger and restart.

Under extreme circumstances, the internal temperature of the battery could become too high. If this happens, the fuel gauge lights will flash in an alternating pattern and the tool will not run. Allow the battery to cool down.

Fuel Gauge Lights	Diagnosis	Solution
Lights 1 - 4 Solid	Remaining run time	Continue working
1 Light, flashing slowly	Less than 10% run time left	Prepare to charge pack
1 Light, flashing quickly	End of discharge	Charge pack
Lights 1-4, flashing quickly	Current draw too high	Release trigger and restart, reduce pressure
Lights 1&3 / 2&4, flashing alternately	Battery temperature too high	Release trigger and allow battery to cool

Cold Weather Operation

MILWAUKEE® Lithium-Ion battery packs are designed to operate in temperatures below freezing. When the battery pack is too cold, it may need to warm up before normal use. Put the battery on a tool and use the tool in a light application. It may "buzz" for a short time until it warms up. When the buzzing stops, use the tool normally.

Maintenance and Storage

Do not expose your battery pack or cordless tools to water or rain, or allow them to get wet. This could damage the tool and battery pack. Do not use oil or solvents to clean or lubricate your battery pack. The plastic casing will become brittle and crack, causing a risk of injury.

Store battery packs at room temperature away from moisture. Do not store in damp locations where corrosion of terminals may occur. As with other battery pack types, permanent capacity loss can result if the pack is stored for long periods of time at high temperatures (over 49°C). MILWAUKEE® Lithium-Ion battery packs maintain their charge during storage longer than other battery pack types. After about a year of storage, charge the pack as normal.

Transport

Personal transport of Li-Ion battery packs is allowed when done in accordance with these warnings and instructions. The proper classification, packaging, labeling, marking, and documentation requirements for shipping Li-Ion batteries is dependent upon whether the particular batteries are rated greater than or less than 100 Wh (Watt Hours can be found on the battery pack nameplate). Generally, Li-Ion batteries rated 100 Wh or less are "excepted" from certain Class 9 DG requirements. Always check compliance of Li-Ion battery consignments against the current regulations governing the chosen mode of transport. When in doubt, contact the carrier or other trained Dangerous Goods professional to confirm acceptability. Li-Ion packs are shipped under classification UN 3480 (battery only) or UN 3481 (batteries contained in or packed with equipment).

⚠️WARNING To reduce the risk of injury or explosion, never burn or incinerate a battery pack even if it is damaged, dead or completely discharged. When burned, toxic fumes and materials are created.

Disposing of MILWAUKEE® Lithium-Ion Battery Packs

MILWAUKEE® Lithium-Ion battery packs are more environmentally friendly than some other types of power tool battery packs (e.g., nickel-cadmium). Always dispose of your battery pack according to federal, state and local regulations. Contact a recycling agency in your area for recycling locations.

Even discharged battery packs contain some energy. Before disposing, use electrical tape to cover the terminals to prevent the battery pack from shorting, which could cause a fire or explosion.

CHARGER OPERATION

⚠WARNING Charge only **MILWAUKEE® M18™** Lithium-Ion batteries in this **MILWAUKEE®** Lithium-Ion charger. Other types of batteries may cause personal injury and damage.

When to Charge the Battery Pack

To charge the battery pack, connect the light to AC power and insert a battery pack. The light will remain operational when the battery pack is charging. **MILWAUKEE®** batteries do not develop a "memory" when charged after only a partial discharge. It is not necessary to run down the battery pack before placing it on the charger.

- Use the Fuel Gauge to determine when to charge your **MILWAUKEE®** Lithium-Ion battery pack.
- You can "Top-Off" your battery pack's charge before starting a big job or long day of use.
- The only time it is necessary to charge the **MILWAUKEE®** Lithium-Ion battery pack is when the battery pack has reached the end of its charge. To signal the end of charge, power to the tool will drop quickly, allowing you just enough power to finish making a cut, drilling a hole, or driving a fastener. Charge the battery pack as needed.

How to Charge the Battery Pack

Plug the light into a 230-240V outlet. The battery pack will not charge if the Light is not plugged in. Align the battery pack with the bay and slide the battery pack into the charger as far as possible.

- When a battery pack is inserted into the charger, the LEDs will indicate the following:



Continuous red: Charging



Continuous green light: Charging is complete



Flashing red: Battery is too hot/cold
Charging will begin when battery reaches correct charging temperature



Flashing red/green: Damaged or faulty battery pack

- A fully discharged battery pack with an internal temperature in the normal range will charge in about 30 to 185 minutes, depending on the battery pack.
- Heavily cycled batteries may take longer to charge completely.
- The Fuel Gauge lights on the battery pack are displayed as the pack is being charged, indicating how fully charged the pack is. The fuel gauge will turn off when charging is complete.
- After charging is complete, the continuous green light will come on.
- The charger will keep the battery pack fully charged if it is left on the charger. The light indicator will flash green during this maintenance charging.
- If the light indicator flashes red and green, check that the battery pack is fully seated into the bay. Remove the pack and reinsert. If the problem persists, contact a **MILWAUKEE®** service facility.
- If the light indicator does not come on, check that the battery pack is fully seated into the bay.

Remove the battery pack and reinsert. If the light indicator still does not come on, contact a **MILWAUKEE®** service facility.

Charging a Hot or Cold Battery Pack

The Red Flashing Indicator light on the charger indicates that the battery pack temperature is outside the charging range. Once the battery pack is within the acceptable range, normal charging will take place and the red light will be continuous. Hot or cold batteries may take longer to charge.

Lithium-Ion Charging Status

Battery Pack Temperature	Red Charger Indicator Light	Charging Status
Too Hot	Fast Flashing	Not charging
Normal Range	Continuous	Normal charging
Too Cold	Fast Flashing	Not charging

MAINTENANCE

⚠WARNING To reduce the risk of injury, always unplug the charger and remove the battery pack from the charger or tool before performing any maintenance. Never disassemble the tool, battery pack or charger. Contact a **MILWAUKEE®** service facility for ALL repairs.

To reduce the risk of fire, personal injury, and product damage due to a short circuit, never immerse your tool, battery pack or charger in fluid or allow a fluid to flow inside them. Corrosive or conductive fluids, such as seawater, certain industrial chemicals, and bleach or products containing bleach, etc., can cause a short circuit.

Maintaining Light

Keep your light, battery pack and charger in good repair by adopting a regular maintenance program. If the light does not work properly, return the light to a **MILWAUKEE®** service facility for repairs.

⚠WARNING To reduce the risk of personal injury and damage, never immerse your tool, battery pack or charger in liquid or allow a liquid to flow inside them.

Cleaning

Clean dust and debris from vents. Keep handles clean, dry and free of oil or grease. Use only mild soap and a damp cloth to clean, since certain cleaning agents and solvents are harmful to plastics and other insulated parts. Some of these include gasoline, turpentine, lacquer thinner, paint thinner, chlorinated cleaning solvents, ammonia and household detergents containing ammonia. Never use flammable or combustible solvents around tools.

Repairs

For repairs, return the tool, battery pack and charger to the nearest authorised service centre.

ACCESSORIES

⚠WARNING Use only recommended accessories. Others may be hazardous.

For a complete listing of accessories, go online to milwaukeetool.com.au/ milwaukeetool.co.nz or contact a distributor.

WARRANTY - AUSTRALIA and NEW ZEALAND

Please refer to Australian and New Zealand warranty supplied with tool. This warranty applies only to product sold by authorised dealers in Australia and New Zealand.

SERVICE - AUSTRALIA and NEW ZEALAND

MILWAUKEE® prides itself in producing a premium quality product that is Nothing But Heavy Duty™. Your satisfaction with our products is very important to us! If you encounter any problems with the operation of this tool, please contact your authorised **MILWAUKEE®** dealer.

For a list of **MILWAUKEE®** dealers, guarantee or service agents please contact **MILWAUKEE®** Customer Service or visit our website.

(Australia Toll Free Telephone Number 1300 645 928)

(New Zealand Toll Free Telephone Number 0800 645 928)

or visit milwaukeeetool.com.au/milwaukeeetool.co.nz.

Milwaukee Electric Tool Corporation

13135 West Lisbon Road, Brookfield, Wisconsin U.S.A. 53005

Milwaukee Tool (Australia)

21 Kelletts Road, Rowville, VIC 3178
Melbourne, Australia

Milwaukee Tool (New Zealand)

274 Church Street, Penrose,
Auckland, 1061, New Zealand

DESIGNED BY MILWAUKEE ELECTRIC TOOL CORP.
PROFESSIONALLY MADE IN CHINA
PRINTED IN CHINA

All trade marks are owned by Techtronic Cordless GP unless otherwise stated.
© 2020 Milwaukee Electric Tool Corporation.