

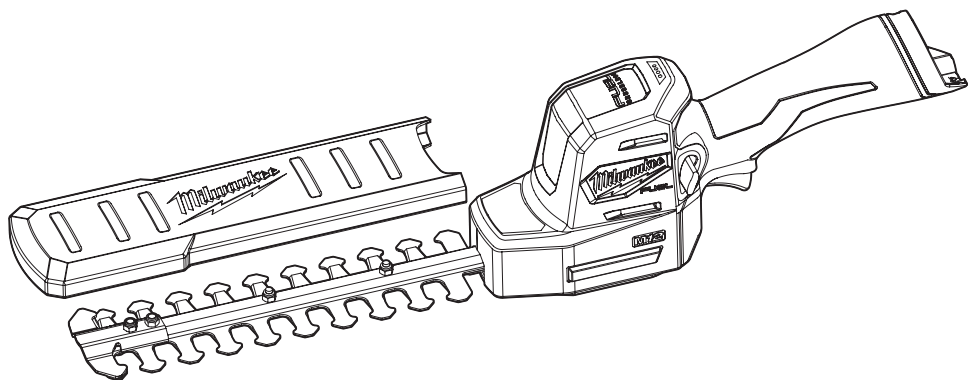



OPERATOR'S MANUAL



Cat. No.
M12 FHT

M12 FUEL™ HEDGE TRIMMER

 **WARNING**

 To reduce the risk of injury, user must read and understand operator's manual.

GENERAL POWER TOOL SAFETY WARNINGS

WARNING Read all safety warnings, instructions, illustrations and specifications provided with this power tool. Failure to follow all instructions listed below may result in electric shock, fire and/or serious injury. **Save all warnings and instructions for future reference.** The term "power tool" in the warnings refers to your mains-operated (corded) power tool or battery-operated (cordless) power tool.

WORK AREA SAFETY

- **Keep work area clean and well lit.** Cluttered or dark areas invite accidents.
- **Do not operate power tools in explosive atmospheres, such as in the presence of flammable liquids, gases or dust.** Power tools create sparks which may ignite the dust or fumes.
- **Keep children and bystanders away while operating a power tool.** Distractions can cause you to lose control.

ELECTRICAL SAFETY

- **Power tool plugs must match the outlet. Never modify the plug in any way. Do not use any adapter plugs with earthed (grounded) power tools.** Unmodified plugs and matching outlets will reduce risk of electric shock.
- **Avoid body contact with earthed or grounded surfaces, such as pipes, radiators, ranges and refrigerators.** There is an increased risk of electric shock if your body is earthed or grounded.
- **Do not expose power tools to rain or wet conditions.** Water entering a power tool will increase the risk of electric shock.
- **Do not abuse the cord. Never use the cord for carrying, pulling or unplugging the power tool. Keep cord away from heat, oil, sharp edges or moving parts.** Damaged or entangled cords increase the risk of electric shock.
- **When operating a power tool outdoors, use an extension cord suitable for outdoor use.** Use of a cord suitable for outdoor use reduces the risk of electric shock.
- **If operating a power tool in a damp location is unavoidable, use a residual current device (RCD) protected supply.** Use of a RCD reduces the risk of electric shock.

PERSONAL SAFETY

- **Stay alert, watch what you are doing and use common sense when operating a power tool. Do not use a power tool while you are tired or under the influence of drugs, alcohol, or medication.** A moment of inattention while operating power tools may result in serious personal injury.
- **Use personal protective equipment. Always wear eye protection.** Protective equipment such as a dust mask, non-skid safety shoes, hard hat or hearing protection used for appropriate conditions will reduce personal injuries.
- **Prevent unintentional starting. Ensure the switch is in the off-position before connecting to power source and/or battery pack, picking up or carrying the tool.** Carrying power tools with your finger on the switch or energising power tools that have the switch on invites accidents.

- **Remove any adjusting key or wrench before turning the power tool on.** A wrench or a key left attached to a rotating part of the power tool may result in personal injury.
- **Do not overreach. Keep proper footing and balance at all times.** This enables better control of the power tool in unexpected situations.
- **Dress properly. Do not wear loose clothing or jewellery. Keep your hair and clothing away from moving parts.** Loose clothes, jewellery or long hair can be caught in moving parts.
- **If devices are provided for the connection of dust extraction and collection facilities, ensure these are connected and properly used.** Use of dust collection can reduce dust-related hazards.
- **Do not let familiarity gained from frequent use of tools allow you to become complacent and ignore tool safety principles.** A careless action can cause severe injury within a fraction of a second.

POWER TOOL USE AND CARE

- **Do not force the power tool. Use the correct power tool for your application.** The correct power tool will do the job better and safer at the rate for which it was designed.
 - **Do not use the power tool if the switch does not turn it on and off.** Any power tool that cannot be controlled with the switch is dangerous and must be repaired.
 - **Disconnect the plug from the power source and/ or remove the battery pack, if detachable, from the power tool before making any adjustments, changing accessories, or storing power tools.** Such preventive safety measures reduce the risk of starting the power tool accidentally.
 - **Store idle power tools out of the reach of children and do not allow persons unfamiliar with the power tool or these instructions to operate the power tool.** Power tools are dangerous in the hands of untrained users.
 - **Maintain power tools and accessories. Check for misalignment or binding of moving parts, breakage of parts and any other condition that may affect the power tool's operation. If damaged, have the power tool repaired before use.** Many accidents are caused by poorly maintained power tools.
 - **Keep cutting tools sharp and clean.** Properly maintained cutting tools with sharp cutting edges are less likely to bind and are easier to control.
 - **Use the power tool, accessories and tool bits etc. in accordance with these instructions, taking into account the working conditions and the work to be performed.** Use of the power tool for operations different from those intended could result in a hazardous situation.
 - **Keep handles and grasping surfaces dry, clean and free from oil and grease.** Slippery handles and grasping surfaces do not allow for safe handling and control of the tool in unexpected situations.
- ### BATTERY TOOL USE AND CARE
- **Recharge only with the charger specified by the manufacturer.** A charger that is suitable for one type of battery pack may create a risk of fire when used with another battery pack.
 - **Use power tools only with specifically designated battery packs.** Use of any other battery packs may create a risk of injury and fire.

•When battery pack is not in use, keep it away from other metal objects, like paper clips, coins, keys, nails, screws or other small metal objects, that can make a connection from one terminal to another. Shorting the battery terminals together may cause burns or a fire.

•Under abusive conditions, liquid may be ejected from the battery; avoid contact. If contact accidentally occurs, flush with water. If liquid contacts eyes, additionally seek medical help. Liquid ejected from the battery may cause irritation or burns.

•Do not use a battery pack or tool that is damaged or modified. Damaged or modified batteries may exhibit unpredictable behaviour resulting in fire, explosion or risk of injury.

•Do not expose a battery pack or tool to fire or excessive temperature. Exposure to fire or temperature above 130°C (265°F) may cause explosion.

•Follow all charging instructions and do not charge the battery pack or tool outside the temperature range specified in the instructions. Charging improperly or at temperatures outside the specified range may damage the battery and increase the risk of fire.

SERVICE

•Have your power tool serviced by a qualified repair person using only identical replacement parts. This will ensure that the safety of the power tool is maintained.

•Never service damaged battery packs. Service of battery packs should only be performed by the manufacturer or authorised service providers.

SPECIFIC SAFETY RULES FOR HEDGE TRIMMERS

⚠DANGER Keep all parts of the body away from the blade. Do not remove cut material or hold material to be cut when blades are moving. Blades continue to move after the switch is turned off. A moment of inattention while operating the hedge trimmer may result in serious personal injury.

•Carry the hedge trimmer by the handle with the blade stopped and taking care not to operate any power switch. Proper carrying of the hedge trimmer will decrease the risk of inadvertent starting and resultant personal injury from the blades.

•When transporting or storing the hedge trimmer, always fit the blade cover. Proper handling of the hedge trimmer will decrease the risk of personal injury from the blades.

•When clearing jammed material or servicing the unit, make sure all power switches are off and the battery pack is removed or disconnected. Unexpected actuation of the hedge trimmer while clearing jammed material or servicing may result in serious personal injury.

•Hold the hedge trimmer by insulated gripping surfaces only, because the blade may contact hidden wiring. Blades contacting a "live" wire may make exposed metal parts of the hedge trimmer "live" and could give the operator an electric shock.

•Keep all power cords and cables away from cutting area. Power cords or cables may be hidden in hedges or bushes and can be accidentally cut by the blade.

•Do not use the hedge trimmer in bad weather conditions, especially when there is a risk of lightning. This decreases the risk of being struck by lightning.

⚠WARNING To reduce the risk of injury, when working in dusty situations, wear appropriate respiratory protection or use a suitable dust extraction solution.

•Do not use tool while standing on unstable support. Stable footing on a solid surface enables better control of the tool in unexpected situations.

•To reduce the risk of injury, user must read operator's manual. Risk of eye injury. Always wear eye protection, hearing protection, and protective clothing and footwear. Keep bystanders at least 4.5 m away during use. Objects may be thrown or ricochet in all directions. Avoid accidental startup; do not pick up or carry tool by trigger. Always remove battery pack before making adjustments or storing. Do not expose to rain; store indoors. Use M12™ batteries.

•Before starting the trimmer check the work area for hidden objects, such as wires, fencing, etc. Striking a solid object could cause loss of control and serious personal injury.

•Do not start the trimmer with blade in contact with an object. Allow tool to reach full speed before starting the job.

•Never cut any material with a diameter larger than 9.5 mm. The tool may stall or kickback, causing a risk of injury.

•Always remove the battery pack when tool is not in use.

•Always use common sense and be cautious when using tools. It is not possible to anticipate every situation that could result in a dangerous outcome. Do not use this tool if you do not understand these operating instructions or you feel the work is beyond your capability; contact MILWAUKEE® Tool or a trained professional for additional information or training.

•This tool is intended to be used at ground level and not on ladders or other unstable supports.

•Maintain labels and nameplates. These carry important information. If unreadable or missing, contact a MILWAUKEE® service facility for a replacement.

⚠WARNING Some dust created by power sanding, sawing, grinding, drilling, and other construction activities contains chemicals known to cause cancer, birth defects or other reproductive harm. Some examples of these chemicals are:

•lead from lead-based paint

•crystalline silica from bricks and cement and other masonry products, and

•arsenic and chromium from chemically-treated lumber.

Your risk from these exposures varies, depending on how often you do this type of work. To reduce your exposure to these chemicals: work in a well ventilated area, and work with approved safety equipment, such as those dust masks that are specially designed to filter out microscopic particles.

ADDITIONAL BATTERY SAFETY RULES









⚠WARNING To reduce the risk of fire, personal injury, and product damage due to a short circuit, never immerse your tool, battery pack or charger in fluid or allow a fluid to flow inside them. Corrosive or conductive fluids, such as seawater, certain industrial chemicals, and bleach or bleach-containing products, etc., can cause a short circuit.

⚠WARNING Do not charge non-rechargeable batteries.

SPECIFICATIONS

Cat. No.	M12 FHT
Volts	12V DC
Battery Type	M12™
Charger Type	M12™
Blade Length	200 mm
Cutting Capacity (diameter)	13 mm
Cutting Speed	2,700 SPM
Recommended Ambient Operating Temperature	-17°C to 51°C

SYMBOLOLOGY

- V** Volts
- Direct Current
- n_0 XXXX min⁻¹ No Load Strokes per Minute (SPM)
-  Safety Alert Symbol
-  Read Operator's Manual
-  Always wear eye protection, hearing protection, and protective clothing and footwear.
-  Always wear gloves and personal protective equipment.
-  Keep hands, feet, and body away from blade.
-  Do not use in rain or wet locations.
-  Keep bystanders 4.5 m away during use.
-  Regulatory Compliance Mark (RCM). This product meets applicable regulatory requirements.

Do not dispose of electric tools together with household waste material. Electric tools and electronic equipment that have reached the end of their life must be collected separately and returned to an environmentally compatible recycling facility.



FUNCTIONAL DESCRIPTION

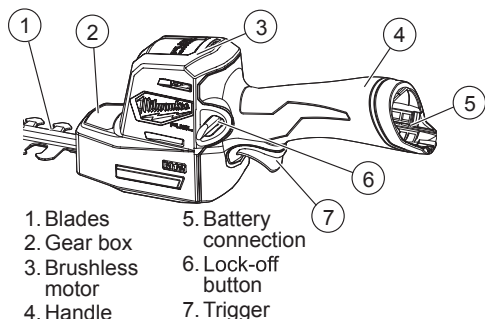

1. Blades
2. Gear box
3. Brushless motor
4. Handle
5. Battery connection
6. Lock-off button
7. Trigger

ASSEMBLY

▲WARNING Recharge only with the charger specified for the battery. For specific charging instructions, read the operator's manual supplied with your charger and battery.

Removing/Inserting the Battery

To remove the battery, push in the release buttons and pull the battery pack away from the tool.

▲WARNING Always lock the trigger or remove the battery pack any time the tool is not in use.

To insert the battery, slide the pack into the body of the tool. Make sure it latches securely into place.

▲WARNING Only use accessories specifically recommended for this tool. Others may be hazardous.

Blade Cover

Always place the blade cover over the blade before moving from one job to another, storing or transporting the tool.

▲WARNING Blade is sharp. Keep hands and body away from blade.

1. Remove battery pack.
2. Slide the blade cover over the blade. It may be necessary to push with some force as blade cover reaches the front guard.
3. To remove, pull blade cover off of blade. It may be necessary to pull with some force until cover clears the detent near the guard.

▲WARNING Always turn off the tool between cuts or when transporting from one location to another. Do not carry tool with finger on the trigger. Accidental starting can cause serious personal injury.

Transporting

Always remove the battery pack and cover the blade before transporting. Carry tool by the handle. Do not carry tool with fingers on trigger.

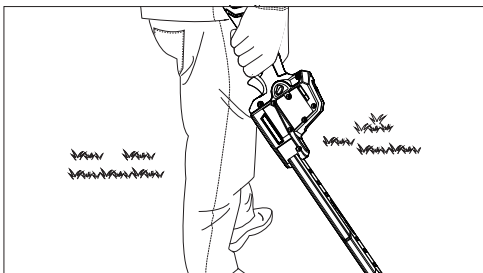

▲WARNING To reduce the risk of injury, always remove the battery pack from the tool before lubricating.

Lubricating the Blade

To extend cutting life, lubricate the trimmer blades before and after each use and before storing.

1. Remove the battery pack.
2. Apply machine oil along both sides of the top blade.

OPERATION

⚠WARNING To reduce the risk of injury, always wear proper eye protection marked to comply with AS/NZS 1337.1. Use only recommended accessories. Others may be hazardous. To reduce the risk of injury, user must read operator's manual. Risk of eye injury. Always wear eye protection, hearing protection, and protective clothing and footwear. Keep bystanders at least 4.5 m away during use. Objects may be thrown or ricochet in all directions. Avoid accidental startup; do not pick up or carry tool by trigger.

Starting and Stopping the Tool

1. Always remove the blade cover before use.
2. Hold the handle securely.

⚠WARNING Blade is sharp. Keep hands and body away from blade.

3. To start the tool, push the lock-off trigger down and then pull the trigger. Allow the motor to reach full speed before starting to cut.
4. To stop the tool, release the trigger.
5. Always wait for blades to stop before setting down.

⚠WARNING To reduce the risk of injury, always keep one hand on the handle. Do not remove cut material or hold material to be cut when blades are moving.

Cutting Tips

⚠DANGER Never cut near electric cords or lines. If blade cuts into or jams on any electrical cord or line, cutter blades may become "live" and shock the operator! Disconnect the electrical service to the electrical line before attempting to free the blade from the line. Contact with the blade, line, or other live electrical part could result in death or serious injury.

Before starting the tool check the work area for hidden objects, such as wires, fencing, etc. Striking a solid object could cause loss of control and serious personal injury.

- Use a sweeping, back and forth motion, moving down or across the work.
- Move the tool at a slower pace when cutting thicker branches. Do not force the tool. The blade will slow and could bind.
- Do not cut branches with a diameter greater than 9.5 mm. Use a Sawzall™ or Hackzall™ reciprocating saw with a pruning blade for thicker branches.
- If blades jam, stop the tool and remove the battery pack.

⚠WARNING Use caution when removing debris from the blades.

•For straight cuts, stretch a string along the work area just below the desired cut height. Use the string as a guide when cutting. Hold the tool at a 0° to 10° angle when cutting a flat top.

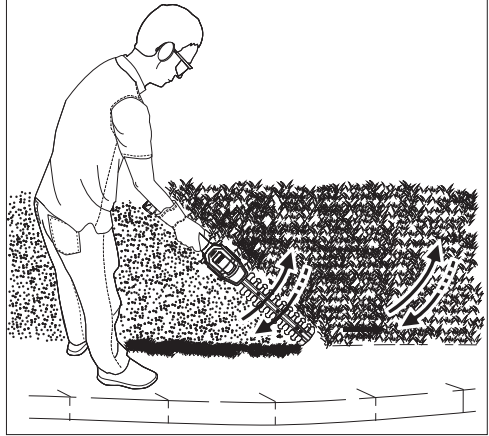
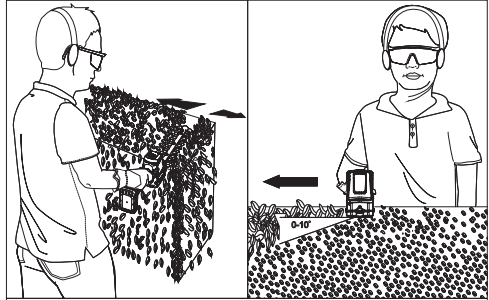

MAINTENANCE

⚠WARNING To reduce the risk of injury, always unplug the charger and remove the battery pack from the charger and tool before performing any maintenance. Never disassemble the tool, battery pack or charger. Contact a MILWAUKEE® service facility for ALL repairs.

Maintaining Tool

Keep your tool, battery pack and charger in good repair by adopting a regular maintenance program. Inspect your tool for issues such as undue noise, misalignment or binding of moving parts, breakage of parts, or any other condition that may affect the tool operation. Return the tool, battery pack, and charger to a MILWAUKEE® service facility for repair. After six months to one year, depending on use, return the tool, battery pack and charger to a MILWAUKEE® service facility for inspection.

If the tool does not start or operate at full power with a fully charged battery pack, clean the contacts on the battery pack. If the tool still does not work properly, return the tool, charger and battery pack, to a MILWAUKEE® service facility for repairs.

Sharpening Blade

1. Stop the tool so the teeth appear in an offset position (see picture).
2. Remove the battery pack from the tool.
3. Secure the blade in a vice and file the exposed cutting surface of each cutting blade tooth with a file. Do not change the cutting angle of the cutting teeth.
4. To sharpen the other side of the teeth, restart the tool to offset the teeth in the opposite position. Remove the battery pack before re-securing in the vice.

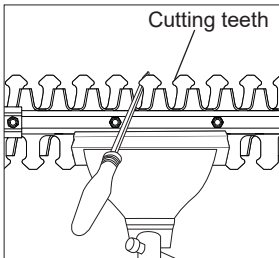

⚠WARNING To reduce the risk of personal injury and damage, never immerse your tool, battery pack or charger in liquid or allow a liquid to flow inside them.

Cleaning

Clean dust and debris from any vents. Keep tool clean, dry and free of oil or grease. Use only mild soap and a damp cloth to clean, since certain cleaning agents and solvents are harmful to plastics and other insulated parts. Some of these include gasoline, turpentine, lacquer thinner, paint thinner, chlorinated cleaning solvents, ammonia and household detergents containing ammonia. Never use flammable or combustible solvents around tools.

Repairs

For repairs, return the tool, battery pack and charger to the nearest authorised service centre.

ACCESSORIES

⚠WARNING Use only recommended accessories. Others may be hazardous.

For a complete listing of accessories, go online to milwaukeeetool.com.au / milwaukeeetool.co.nz or contact a distributor.

WARRANTY - AUSTRALIA and NEW ZEALAND

Please refer to Australian and New Zealand warranty supplied with tool. This warranty applies only to product sold by authorised dealers in Australia and New Zealand.

SERVICE - AUSTRALIA and NEW ZEALAND

MILWAUKEE® prides itself in producing a premium quality product that is Nothing But Heavy Duty™. Your satisfaction with our products is very important to us! If you encounter any problems with the operation of this tool, please contact your authorised **MILWAUKEE®** dealer.

For a list of **MILWAUKEE®** dealers, guarantee or service agents please contact **MILWAUKEE®** Customer Service or visit our website.

(Australia Toll Free Telephone Number 1300 645 928)

(New Zealand Toll Free Telephone Number 0800 645 928)

or visit milwaukeetool.com.au/milwaukeetool.co.nz.

Milwaukee Electric Tool Corporation

13135 West Lisbon Road, Brookfield, Wisconsin U.S.A. 53005

Milwaukee Tool (Australia)

26 - 40 Nina Link, Dandenong South,
Victoria, 3175, Australia

Milwaukee Tool (New Zealand)

274 Church Street, Penrose,
Auckland, 1061, New Zealand

DESIGNED BY MILWAUKEE ELECTRIC TOOL CORP.
PROFESSIONALLY MADE IN CHINA
PRINTED IN CHINA