

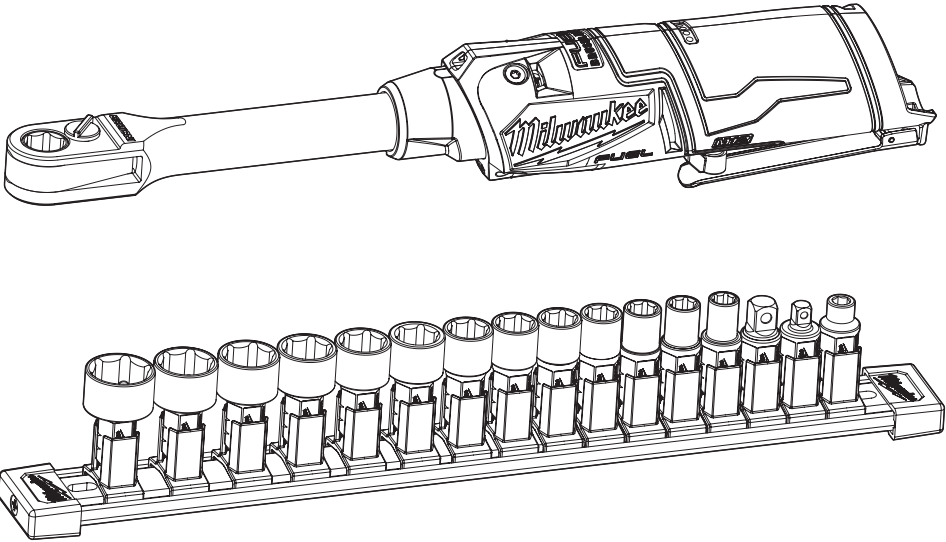

## OPERATOR'S MANUAL



Cat. No.  
**M12 FPTR**

## **M12 FUEL™ INSIDER EXTENDED REACH PASS-THROUGH RATCHET WITH ACCESSORIES**

 **WARNING**

 To reduce the risk of injury, user must read and understand operator's manual.

## GENERAL POWER TOOL SAFETY WARNINGS

**WARNING** Read all safety warnings, instructions, illustrations and specifications provided with this power tool. Failure to follow all instructions listed below may result in electric shock, fire and/or serious injury. **Save all warnings and instructions for future reference.** The term "power tool" in the warnings refers to your mains-operated (corded) power tool or battery-operated (cordless) power tool.

### WORK AREA SAFETY

- **Keep work area clean and well lit.** Cluttered or dark areas invite accidents.
- **Do not operate power tools in explosive atmospheres, such as in the presence of flammable liquids, gases or dust.** Power tools create sparks which may ignite the dust or fumes.
- **Keep children and bystanders away while operating a power tool.** Distractions can cause you to lose control.

### ELECTRICAL SAFETY

- **Power tool plugs must match the outlet. Never modify the plug in any way. Do not use any adapter plugs with earthed (grounded) power tools.** Unmodified plugs and matching outlets will reduce risk of electric shock.
- **Avoid body contact with earthed or grounded surfaces, such as pipes, radiators, ranges and refrigerators.** There is an increased risk of electric shock if your body is earthed or grounded.
- **Do not expose power tools to rain or wet conditions.** Water entering a power tool will increase the risk of electric shock.
- **Do not abuse the cord. Never use the cord for carrying, pulling or unplugging the power tool. Keep cord away from heat, oil, sharp edges or moving parts.** Damaged or entangled cords increase the risk of electric shock.
- **When operating a power tool outdoors, use an extension cord suitable for outdoor use.** Use of a cord suitable for outdoor use reduces the risk of electric shock.
- **If operating a power tool in a damp location is unavoidable, use a residual current device (RCD) protected supply.** Use of a RCD reduces the risk of electric shock.

### PERSONAL SAFETY

- **Stay alert, watch what you are doing and use common sense when operating a power tool. Do not use a power tool while you are tired or under the influence of drugs, alcohol or medication.** A moment of inattention while operating power tools may result in serious personal injury.
- **Use personal protective equipment. Always wear eye protection.** Protective equipment such as a dust mask, non-skid safety shoes, hard hat or hearing protection used for appropriate conditions will reduce personal injuries.
- **Prevent unintentional starting. Ensure the switch is in the off-position before connecting to power source and/or battery pack, picking up or carrying the tool.** Carrying power tools with your finger on the switch or energising power tools that have the switch on invites accidents.

- **Remove any adjusting key or wrench before turning the power tool on.** A wrench or a key left attached to a rotating part of the power tool may result in personal injury.
- **Do not overreach. Keep proper footing and balance at all times.** This enables better control of the power tool in unexpected situations.
- **Dress properly. Do not wear loose clothing or jewellery. Keep your hair and clothing away from moving parts.** Loose clothes, jewellery or long hair can be caught in moving parts.
- **If devices are provided for the connection of dust extraction and collection facilities, ensure these are connected and properly used.** Use of dust collection can reduce dust-related hazards.
- **Do not let familiarity gained from frequent use of tools allow you to become complacent and ignore tool safety principles.** A careless action can cause severe injury within a fraction of a second.

### POWER TOOL USE AND CARE

- **Do not force the power tool. Use the correct power tool for your application.** The correct power tool will do the job better and safer at the rate for which it was designed.
- **Do not use the power tool if the switch does not turn it on and off.** Any power tool that cannot be controlled with the switch is dangerous and must be repaired.
- **Disconnect the plug from the power source and/or remove the battery pack, if detachable, from the power tool before making any adjustments, changing accessories, or storing power tools.** Such preventive safety measures reduce the risk of starting the power tool accidentally.
- **Store idle power tools out of the reach of children and do not allow persons unfamiliar with the power tool or these instructions to operate the power tool.** Power tools are dangerous in the hands of untrained users.
- **Maintain power tools and accessories. Check for misalignment or binding of moving parts, breakage of parts and any other condition that may affect the power tool's operation. If damaged, have the power tool repaired before use.** Many accidents are caused by poorly maintained power tools.
- **Keep cutting tools sharp and clean.** Properly maintained cutting tools with sharp cutting edges are less likely to bind and are easier to control.
- **Use the power tool, accessories and tool bits etc. in accordance with these instructions, taking into account the working conditions and the work to be performed.** Use of the power tool for operations different from those intended could result in a hazardous situation.
- **Keep handles and grasping surfaces dry, clean and free from oil and grease.** Slippery handles and grasping surfaces do not allow for safe handling and control of the tool in unexpected situations.

### BATTERY TOOL USE AND CARE

- **Recharge only with the charger specified by the manufacturer.** A charger that is suitable for one type of battery pack may create a risk of fire when used with another battery pack.
- **Use power tools only with specifically designated battery packs.** Use of any other battery packs may create a risk of injury and fire.

•Under abusive conditions, liquid may be ejected from the battery; avoid contact. If contact accidentally occurs, flush with water. If liquid contacts eyes, additionally seek medical help. Liquid ejected from the battery may cause irritation or burns.

•Do not use a battery pack or tool that is damaged or modified. Damaged or modified batteries may exhibit unpredictable behaviour resulting in fire, explosion or risk of injury.

•Do not expose a battery pack or tool to fire or excessive temperature. Exposure to fire or temperature above 130°C (265°F) may cause explosion.

•Follow all charging instructions and do not charge the battery pack or tool outside the temperature range specified in the instructions. Charging improperly or at temperatures outside the specified range may damage the battery and increase the risk of fire.

### SERVICE

•Have your power tool serviced by a qualified repair person using only identical replacement parts. This will ensure that the safety of the power tool is maintained.

•Never service damaged battery packs. Service of battery packs should only be performed by the manufacturer or authorised service providers.

### SPECIFIC SAFETY RULES FOR RATCHETS

•Hold the power tool by insulated gripping surfaces, when performing an operation where the fastener may contact hidden wiring. Fasteners contacting a "live" wire may make exposed metal parts of the power tool "live" and could give the operator an electric shock.

**AWARNING** To reduce the risk of injury, when working in dusty situations, wear appropriate respiratory protection or use a suitable dust extraction solution.

•Always use common sense and be cautious when using tools. It is not possible to anticipate every situation that could result in a dangerous outcome. Do not use this tool if you do not understand these operating instructions or you feel the work is beyond your capability; contact MILWAUKEE® Tool or a trained professional for additional information or training.

•Maintain labels and nameplates. These carry important information. If unreadable or missing, contact a MILWAUKEE® service facility for a replacement.

**AWARNING** Some dust created by power sanding, sawing, grinding, drilling, and other construction activities contains chemicals known to cause cancer, birth defects or other reproductive harm. Some examples of these chemicals are:

- lead from lead-based paint
- crystalline silica from bricks and cement and other masonry products, and
- arsenic and chromium from chemically-treated lumber.

Your risk from these exposures varies, depending on how often you do this type of work. To reduce your exposure to these chemicals: work in a well ventilated area, and work with approved safety equipment, such as those dust masks that are specially designed to filter out microscopic particles.

### ADDITIONAL BATTERY SAFETY RULES

**AWARNING** To reduce the risk of fire, personal injury, and product damage due to a short circuit, never immerse your tool, battery pack or charger in fluid or allow a fluid to flow inside them. Corrosive or conductive fluids, such as seawater, certain industrial chemicals, and bleach or bleach-containing products, etc., can cause a short circuit.

**AWARNING** Do not charge non-rechargeable batteries.

### SPECIFICATIONS

Cat. No. ....	M12 FPTR
Volts. ....	12 V DC
Battery Type .....	M12™
Charger Type .....	M12™
RPM .....	0 - 350
Max Torque .....	81.3 Nm (60 ft-Lbs)
Recommended Ambient Operating Temperature.....	-17°C to 51°C

### SYMBOLGY

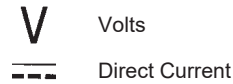

n, XXXX min<sup>-1</sup> No Load Revolutions per Minute (RPM)



Lock



Unlock



Read Operator's Manual



Regulatory Compliance Mark (RCM). This product meets applicable regulatory requirements.

Do not dispose of electric tools together with household waste material. Electric tools and electronic equipment that have reached the end of their life must be collected separately and returned to an environmentally compatible recycling facility.

### FUNCTIONAL DESCRIPTION

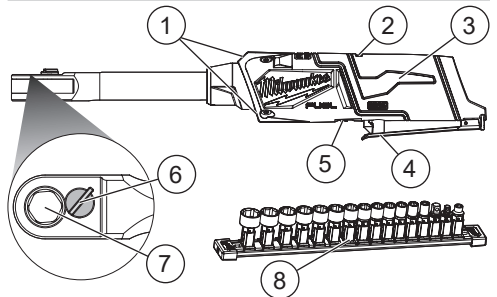

- |                           |   |
|---------------------------|---|
| 1. LED                    | 6. Forward/ Reverse toggle                |
| 2. Fuel gauge             | 7. Duel retention spline                  |
| 3. Handle                 | 8. Metric sockets and anvil/ Hex adapters |
| 4. Variable paddle switch |   |
| 5. Lock switch            |   |

## ASSEMBLY

**⚠WARNING** Recharge only with the charger specified for the battery. For specific charging instructions, read the operator's manual supplied with your charger and battery.

### Inserting/Removing the Battery

To **insert** the battery, slide the pack into the body of the tool. Make sure it latches securely into place. To **remove** the battery, push in the release buttons and pull the battery pack away from the tool.

**⚠WARNING** Only use accessories specifically recommended for this tool.

Others may be hazardous.

**⚠WARNING** Always remove the battery pack any time the tool is not in use.

Only use **MILWAUKEE®**-designed M12 FUEL™ INSIDER Extended Reach Pass-Through Ratchet sockets and anvil adapters. Other sockets and anvil adapters could shatter or break, causing injury.

### Attaching/Removing Sockets and Adapters

**⚠WARNING** Remove battery to avoid starting the tool.

•To **insert** the adapter into the ratchet, line up the adapter with the spline opening on the ratchet, and push firmly until they click together. Insert from the bottom or top of the tool, as shown. Ensure the adapter is secured in place before use. Some **MILWAUKEE®** sockets can be used without an anvil adapter.

•To **attach** a socket or accessory, press it firmly into place on the adapter.

•To **remove** the socket or accessory, pull firmly away from the tool.

•To **remove** the adapter, pull the adapter out of the ratchet spline.

**NOTE:** Choose the correct accessory for the job.

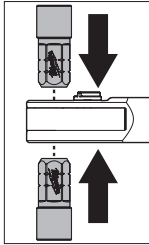

## OPERATION

**⚠WARNING** To reduce the risk of injury, always wear proper eye protection marked to comply with AS/NZS 1337.1.

When working in dusty situations, wear appropriate respiratory protection or use a suitable dust extraction solution.

### Fuel Gauge

To determine the amount of charge left in the battery, turn the tool **ON**. The Fuel Gauge will light up for 2-3 seconds. When less than 10% of charge is left, 1 light on the fuel gauge will flash 4 times.

To signal the end of charge, 1 light on the fuel gauge will flash 8 times and the tool will not run. Charge the battery pack.

If the battery becomes too hot, the fuel gauge lights will flash and the tool will not run. Allow the battery to cool down.



### Using the Forward/Reverse Toggle

For **forward** (clockwise) rotation, rotate the forward/reverse toggle counterclockwise. Check the direction of rotation before use.

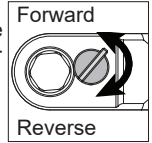
For **reverse** (anticlockwise) rotation, rotate the forward/reverse toggle clockwise. Check the direction of rotation before use.



### Lock Switch

To **lock** the paddle switch, slide the lock switch to the locked  position. To **unlock** the paddle switch, slide the lock switch to the unlocked  position. The paddle switch will not work when the lock switch is in the locked position.

Always lock the paddle switch or remove the battery pack any time the tool is not in use.

### Starting, Stopping and Controlling Speed

1. To **start** the tool, grasp the handle(s) firmly and pull the trigger.

**NOTE:** A LED is turned on when the trigger is pulled and will go off shortly after the trigger is released.

2. To **vary** the speed, increase or decrease the pressure on the trigger. The further the trigger is pulled, the greater the speed.

3. To **stop** the tool, release the trigger. Ensure the tool has come to a complete stop before laying the tool down.

## MAINTENANCE

**▲WARNING** To reduce the risk of injury, always unplug the charger and remove the battery pack from the charger or tool before performing any maintenance. Never disassemble the tool, battery pack or charger. Contact a **MILWAUKEE®** service facility for ALL repairs.

### Maintaining Tool

Keep your tool, battery pack and charger in good repair by adopting a regular maintenance program. Inspect your tool for issues such as undue noise, misalignment or binding of moving parts, breakage of parts, or any other condition that may affect the tool operation. Return the tool, battery pack, and charger to a **MILWAUKEE®** service facility for repair. After six months to one year, depending on use, return the tool, battery pack and charger to a **MILWAUKEE®** service facility for inspection.

If the tool does not start or operate at full power with a fully charged battery pack, clean the contacts on the battery pack. If the tool still does not work properly, return the tool, charger and battery pack, to a **MILWAUKEE®** service facility for repairs.

### Cleaning

Clean dust and debris from vents. Keep handles clean, dry and free of oil or grease. Use only mild soap and a damp cloth to clean, since certain cleaning agents and solvents are harmful to plastics and other insulated parts. Some of these include petrol, turpentine, lacquer thinner, paint thinner, chlorinated cleaning solvents, ammonia and household detergents containing ammonia. Never use flammable or combustible solvents around tools.

### Repairs

For repairs, return the tool, battery pack and charger to the nearest service centre.

## ACCESSORIES

**▲WARNING** Use only recommended accessories. Others may be hazardous.

For a complete listing of accessories, go online to [milwaukeetool.com.au](http://milwaukeetool.com.au) / [milwaukeetool.co.nz](http://milwaukeetool.co.nz) or contact a distributor.





## **WARRANTY - AUSTRALIA and NEW ZEALAND**

Please refer to Australian and New Zealand warranty supplied with tool. This warranty applies only to product sold by authorised dealers in Australia and New Zealand.

## **SERVICE - AUSTRALIA and NEW ZEALAND**

**MILWAUKEE®** prides itself in producing a premium quality product that is Nothing But Heavy Duty™. Your satisfaction with our products is very important to us! If you encounter any problems with the operation of this tool, please contact your authorised **MILWAUKEE®** dealer.

For a list of **MILWAUKEE®** dealers, guarantee or service agents please contact **MILWAUKEE®** Customer Service or visit our website.

(Australia Toll Free Telephone Number 1300 645 928)

(New Zealand Toll Free Telephone Number 0800 645 928)

or visit [milwaukeetool.com.au/milwaukeetool.co.nz](http://milwaukeetool.com.au/milwaukeetool.co.nz).

### **Milwaukee Electric Tool Corporation**

13135 West Lisbon Road, Brookfield, Wisconsin U.S.A. 53005

#### **Milwaukee Tool (Australia)**

26 - 40 Nina Link, Dandenong South,  
Victoria, 3175, Australia

#### **Milwaukee Tool (New Zealand)**

274 Church Street, Penrose,  
Auckland, 1061, New Zealand

DESIGNED BY MILWAUKEE ELECTRIC TOOL CORP.

PROFESSIONALLY MADE IN CHINA

PRINTED IN CHINA