

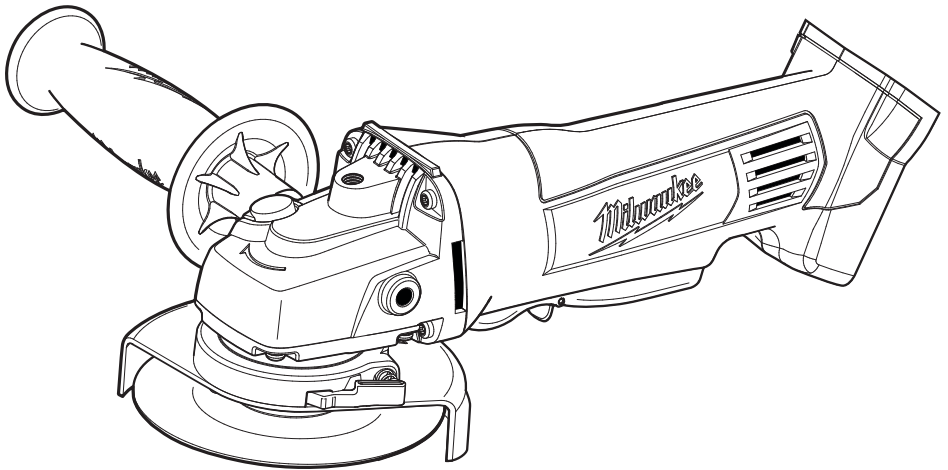

OPERATOR'S MANUAL

**Cat. No.
HD18AG125**



M18™ CORDLESS 125mm (5") CUT-OFF / GRINDER

TO REDUCE THE RISK OF INJURY, USER MUST READ AND UNDERSTAND OPERATOR'S MANUAL.

GENERAL POWER TOOL SAFETY WARNINGS



WARNING READ ALL SAFETY WARNINGS AND ALL INSTRUCTIONS.

Failure to follow the warnings and instructions may result in electric shock, fire and/or serious injury. **Save all warnings and instructions for future reference.** The term "power tool" in the warnings refers to your mains-operated (corded) power tool or battery-operated (cordless) power tool.

WORK AREA SAFETY

- **Keep work area clean and well lit.** Cluttered or dark areas invite accidents.
- **Do not operate power tools in explosive atmospheres, such as in the presence of flammable liquids, gases or dust.** Power tools create sparks which may ignite the dust or fumes.
- **Keep children and bystanders away while operating a power tool.** Distractions can cause you to lose control.

ELECTRICAL SAFETY

- **Power tool plugs must match the outlet. Never modify the plug in any way. Do not use any adapter plugs with earthed (grounded) power tools.** Unmodified plugs and matching outlets will reduce risk of electric shock.
- **Avoid body contact with earthed or grounded surfaces such as pipes, radiators, ranges and refrigerators.** There is an increased risk of electric shock if your body is earthed or grounded.
- **Do not expose power tools to rain or wet conditions.** Water entering a power tool will increase the risk of electric shock.
- **Do not abuse the cord. Never use the cord for carrying, pulling or unplugging the power tool. Keep cord away from heat, oil, sharp edges or moving parts.** Damaged or entangled cords increase the risk of electric shock.
- **When operating a power tool outdoors, use an extension cord suitable for outdoor use.** Use of a cord suitable for outdoor use reduces the risk of electric shock.
- **If operating a power tool in a damp location is unavoidable, use a residual current device (RCD) protected supply.** Use of an RCD reduces the risk of electric shock.

PERSONAL SAFETY

- **Stay alert, watch what you are doing and use common sense when operating a power tool. Do not use a power tool while you are tired or under the influence of drugs, alcohol or medication.** A moment of inattention while operating power tools may result in serious personal injury.
- **Use personal protective equipment. Always wear eye protection.** Protective equipment such as dust mask, non-skid safety shoes, hard hat, or hearing protection used for appropriate conditions will reduce personal injuries.
- **Prevent unintentional starting. Ensure the switch is in the off-position before connecting to power source and/or battery pack, picking up or carrying the tool.** Carrying power tools with your finger on the switch or energising power tools that have the switch on invites accidents.
- **Remove any adjusting key or wrench before turning the power tool on.** A wrench or a key left attached to a rotating part of the power tool may

result in personal injury.

- **Do not overreach. Keep proper footing and balance at all times.** This enables better control of the power tool in unexpected situations.
- **Dress properly. Do not wear loose clothing or jewellery. Keep your hair, clothing and gloves away from moving parts.** Loose clothes, jewellery or long hair can be caught in moving parts.
- **If devices are provided for the connection of dust extraction and collection facilities, ensure these are connected and properly used.** Use of dust collection can reduce dust-related hazards.

POWER TOOL USE AND CARE

- **Do not force the power tool. Use the correct power tool for your application.** The correct power tool will do the job better and safer at the rate for which it was designed.
- **Do not use the power tool if the switch does not turn it on and off.** Any power tool that cannot be controlled with the switch is dangerous and must be repaired.
- **Disconnect the plug from the power source and/or the battery pack from the power tool before making any adjustments, changing accessories, or storing power tools.** Such preventive safety measures reduce the risk of starting the power tool accidentally.
- **Store idle power tools out of the reach of children and do not allow persons unfamiliar with the power tool or these instructions to operate the power tool.** Power tools are dangerous in the hands of untrained users.
- **Maintain power tools. Check for misalignment or binding of moving parts, breakage of parts and any other condition that may affect the power tool's operation. If damaged, have the power tool repaired before use.** Many accidents are caused by poorly maintained power tools.
- **Keep cutting tools sharp and clean.** Properly maintained cutting tools with sharp cutting edges are less likely to bind and are easier to control.
- **Use the power tool, accessories and tool bits etc., in accordance with these instructions, taking into account the working conditions and the work to be performed.** Use of the power tool for operations different from those intended could result in a hazardous situation.

BATTERY TOOL USE AND CARE

- **Recharge only with the charger specified by the manufacturer.** A charger that is suitable for one type of battery pack may create a risk of fire when used with another battery pack.
- **Use power tools only with specifically designated battery packs.** Use of any other battery packs may create a risk of injury and fire.
- **When battery pack is not in use, keep it away from other metal objects like paper clips,**

coins, keys, nails, screws, or other small metal objects that can make a connection from one terminal to another. Shorting the battery terminals together may cause burns or a fire.

- **Under abusive conditions, liquid may be ejected from the battery; avoid contact. If contact accidentally occurs, flush with water. If liquid contacts eyes, additionally seek medical help.** Liquid ejected from the battery may cause irritation or burns.

SERVICE

- **Have your power tool serviced by a qualified repair person using only identical replacement parts.** This will ensure that the safety of the power tool is maintained.

SPECIFIC SAFETY RULES

- **This power tool is intended to function as a grinder, sander, wire brushing or cut-off tool. Read all safety warnings, instructions, illustrations and specifications provided with this power tool.** Failure to follow all instructions listed below may result in electric shock, fire and/or serious injury.
- **Operations such as polishing are not recommended to be performed with this power tool.** Operations for which the power tool was not designed may create a hazard and cause personal injury.
- **Do not use accessories which are not specifically designed and recommended by the tool manufacturer.** Just because the accessory can be attached to your power tool, it does not assure safe operation.
- **The rated speed of the accessory must be at least equal to the maximum speed marked on the power tool.** Accessories running faster than their RATED SPEED can break and fly apart.
- **The outside diameter and the thickness of your accessory must be within the capacity rating of your power tool.** Incorrectly sized accessories cannot be adequately guarded or controlled.
- Threaded mounting of accessories must match the grinder spindle thread. For accessories mounted by flanges, the arbour hole of the accessory must fit the locating diameter of the flange. Accessories that do not match the mounting hardware of the power tool will run out of balance, vibrate excessively and may cause loss of control.
- **Do not use a damaged accessory. Before each use inspect the accessory such as abrasive wheels for chips and cracks, backing pad for cracks, tear or excess wear, wire brush for loose or cracked wires. If power tool or accessory is dropped, inspect for damage or install an undamaged accessory. After inspecting and installing an accessory, position yourself and bystanders away from the plane of the rotating accessory and run the power tool at maximum no-load speed for one minute.** Damaged accessories will normally break apart during this test time.
- **Wear personal protective equipment. Depending on application, use face shield, safety goggles or safety glasses. As appropriate, wear dust mask, hearing protectors, gloves**

and workshop apron capable of stopping small abrasive or workpiece fragments. The eye protection must be capable of stopping flying debris generated by various operations. The dust mask or respirator must be capable of filtering particles generated by your operation. Prolonged exposure to high intensity noise may cause hearing loss.

- **Keep bystanders a safe distance away from work area. Anyone entering the work area must wear personal protective equipment.** Fragments of workpiece or of a broken accessory may fly away and cause injury beyond immediate area of operation.
- **Hold the power tool by insulated gripping surfaces only, when performing an operation where the cutting accessory may contact hidden wiring.** Contact with a "live" wire will also make exposed metal parts of the power tool "live" and could give the operator an electric shock.
- **Never lay the power tool down until the accessory has come to a complete stop.** The spinning accessory may grab the surface and pull the power tool out of your control.
- **Do not run the power tool while carrying it at your side.** Accidental contact with the spinning accessory could snag your clothing, pulling the accessory into your body.
- **Regularly clean the power tool's air vents.** The motor's fan will draw the dust inside the housing and excessive accumulation of powdered metal may cause electrical hazards.
- **Do not operate the power tool near flammable materials.** Sparks could ignite these materials.
- **Do not use accessories that require liquid coolants.** Using water or other liquid coolants may result in electrocution or shock.

Kickback and Related Warnings

Kickback is a sudden reaction to a pinched or snagged rotating wheel, backing pad, brush or any other accessory. Pinching or snagging causes rapid stalling of the rotating accessory which in turn causes the uncontrolled power tool to be forced in the direction opposite of the accessory's rotation at the point of the binding.

For example, if an abrasive wheel is snagged or pinched by the workpiece, the edge of the wheel that is entering into the pinch point can dig into the surface of the material causing the wheel to climb out or kick out. The wheel may either jump toward or away from the operator, depending on direction of the wheel's movement at the point of pinching. Abrasive wheels may also break under these conditions.

Kickback is the result of power tool misuse and/or incorrect operating procedures or conditions and can be avoided by taking proper precautions as given below.

- **Maintain a firm grip on the power tool and position your body and arm to allow you to resist kickback forces. Always use auxiliary handle, if provided, for maximum control over kickback or torque reaction during start-up.** The operator can control torque reactions or kickback forces, if proper precautions are taken.
- **Never place your hand near the rotating acces-**

- **sory.** Accessory may kickback over your hand.
- **Do not position your body in the area where power tool will move if kickback occurs.** Kickback will propel the tool in direction opposite to the wheel's movement at the point of snagging.
- **Use special care when working corners, sharp edges etc. Avoid bouncing and snagging the accessory.** Corners, sharp edges or bouncing have a tendency to snag the rotating accessory and cause loss of control or kickback.
- **Do not attach a saw chain woodcarving blade or toothed saw blade.** Such blades create frequent kickback and loss of control.

Safety Warnings Specific for Grinding and Abrasive Cutting-Off Operations:

- **Use only wheel types that are recommended for your power tool and the specific guard designed for the selected wheel.** Wheels for which the power tool was not designed cannot be adequately guarded and are unsafe.
- **The guard must be securely attached to the power tool and positioned for maximum safety, so the least amount of wheel is exposed towards the operator.** The guard helps to protect the operator from broken wheel fragments, accidental contact with wheel and sparks that could ignite clothing.
- **Wheels must be used only for recommended applications. For example: do not grind with the side of cut-off wheel.** Abrasive cut-off wheels are intended for peripheral grinding, side forces applied to these wheels may cause them to shatter.
- **Always use undamaged wheel flanges that are of correct size and shape for your selected wheel.** Proper wheel flanges support the wheel thus reducing the possibility of wheel breakage. Flanges for cut-off wheels may be different from grinding wheel flanges.
- **Do not use worn down wheels from larger power tools.** Wheel intended for larger power tool is not suitable for the higher speed of a smaller tool and may burst.

Additional Safety Warnings Specific for Abrasive Cutting-Off Operations:

- **Do not "jam" the cut-off wheel or apply excessive pressure. Do not attempt to make an excessive depth of cut.** Overstressing the wheel increases the loading and susceptibility to twisting or binding of the wheel in the cut and the possibility of kickback or wheel breakage.
- **Do not position your body in line with and behind the rotating wheel.** When the wheel, at the point of operation, is moving away from your body, the possible kickback may propel the spinning wheel and the power tool directly at you.
- **When wheel is binding or when interrupting a cut for any reason, switch off the power tool and hold the power tool motionless until the wheel comes to a complete stop. Never attempt to remove the cut-off wheel from the cut while the wheel is in motion otherwise kickback may occur.** Investigate and take corrective action to eliminate the cause of wheel binding.
- **Do not restart the cutting operation in the**

- **workpiece. Let the wheel reach full speed and carefully re-enter the cut.** The wheel may bind, walk up or kickback if the power tool is restarted in the workpiece.
- **Support panels or any oversized workpiece to minimize the risk of wheel pinching and kickback.** Large workpieces tend to sag under their own weight. Supports must be placed under the workpiece near the line of cut and near the edge of the workpiece on both sides of the wheel.
- **Use extra caution when making a "pocket cut" into existing walls or other blind areas.** The protruding wheel may cut gas or water pipes, electrical wiring or objects that can cause kickback.

Safety Warnings Specific for Sanding Operations:

- **Do not use excessively oversized sanding disc paper. Follow manufacturers recommendations, when selecting sanding paper.** Larger sanding paper extending beyond the sanding pad presents a laceration hazard and may cause snagging, tearing of the disc or kickback.

Safety Warnings Specific for Wire Brushing Operations:

- **Be aware that wire bristles are thrown by the brush even during ordinary operation. Do not overstress the wires by applying excessive load to the brush.** The wire bristles can easily penetrate light clothing and/or skin.
- **If the use of a guard is recommended for wire brushing, do not allow any interference of the wire wheel or brush with the guard.** Wire wheel or brush may expand in diameter due to work load and centrifugal forces.

Additional Safety Warnings

- **Maintain labels and nameplates.** These carry important information. If unreadable or missing, contact your authorised **MILWAUKEE®** (tm) dealer for a replacement label.
- **WARNING:** Some dust created by power sanding, sawing, grinding, drilling, and other construction activities contains chemicals known to cause cancer, birth defects or other reproductive harm. Some examples of these chemicals are:
 - lead from lead-based paint
 - crystalline silica from bricks and cement and other masonry products, and
 - arsenic and chromium from chemically-treated lumber.
 Your risk from these exposures varies, depending on how often you do this type of work. To reduce your exposure to these chemicals: work in a well ventilated area, and work with approved safety equipment, such as those dust masks that are specially designed to filter out microscopic particles.

ADDITIONAL BATTERY SAFETY RULES

⚠ WARNING To reduce the risk of fire, personal injury, and product damage due to a short circuit, never immerse your tool, battery pack or charger in fluid or allow a fluid to flow inside them. Corrosive or conductive fluids, such as seawater, certain industrial chemicals, and bleach or bleach-containing products, etc., can cause a short circuit.

SPECIFICATIONS

Cat. No.	Volts DC	No Load RPM	Spindle Thread Size	Wheel Thickness Size
HD18 AG125	18	10000	M14	125mm (5")

SYMBOLLOGY

V	Volts
— — —	Direct Current
n_0 XXXXmin. ⁻¹	No Load Revolutions per Minute (RPM)
	Regulatory Compliance mark (RCM). This product meets applicable regulatory requirements.

FUNCTIONAL DESCRIPTION

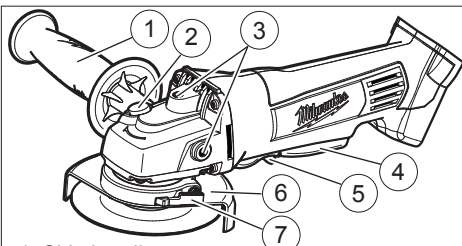

- | | |
|------------------------|---------------------|
| 1. Side handle | 5. Switch lock-off |
| 2. Spindle lock | 6. Guard |
| 3. Side handle sockets | 7. Guard lock lever |
| 4. Paddle switch | |

ASSEMBLY

⚠ WARNING Recharge only with the charger specified for the battery. For specific charging instructions, read the operator's manual supplied with your charger and battery.

Inserting/Removing the Battery

To **remove** the battery, push in the release buttons and pull the battery pack away from the tool.

To **insert** the battery, slide the pack into the body of the tool. Make sure it latches securely into place.

⚠ WARNING Always remove battery pack before changing or removing accessories. Only use accessories specifically recommended for this tool. Others may be hazardous.

Installing Side Handle

The side handle may be installed on either side or the top of gear case. Position side handle in the location which offers best control and guard protection. To install, thread side handle into side handle socket and tighten securely.

⚠ WARNING To reduce the risk of injury when grinding:

- **ALWAYS** use the proper guard.
- **ALWAYS** properly install the guard.
- **ALWAYS** hold the tool firmly with both hands using the handles provided before and during grinding.
- **NEVER** use a wheel that has been dropped.
- **NEVER** bang grinding disc onto work.
- **NEVER** grind without proper safety equipment.

Installing, Removing and Adjusting the Guard

This tool is shipped with a guard. A guard must be used when using the tool as a grinder. The guard may be removed when using tool as a sander.

1. To **remove** the guard, remove the battery pack and remove any accessories from spindle.
2. Press in the lock lever and rotate the guard to line up the tabs on the grinder with the slots in the guard.
3. Press in the lock lever and lift the guard straight up and away from the tool.
4. To **install** the guard, remove the battery pack and remove any accessories from the spindle.
5. Line up the tabs on the grinder with the slots in the guard.
6. Press in the lock lever and press the guard onto the tool.
7. To **adjust** the guard, press in the lock lever and rotate the guard to one of five detent slots.

Fig. 1

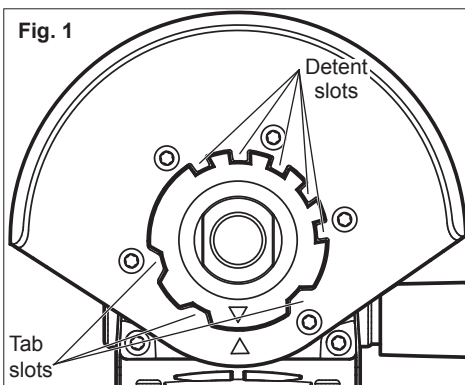

⚠ WARNING Only use accessories with Maximum Safe Operating Speed rated at least equal to the maximum speed marked on the power tool. This speed is based on the strength of the wheel, allowing for a reasonable measure of safety. It is not meant to imply a best or most efficient operating speed. Do not exceed the Maximum Safe Operating Speed.

Installing/Removing Accessories

Make sure the wheel does not extend beyond the bottom of the guard. Threaded hub grinding wheels may require a deeper guard (see "Accessories").

1. Remove the battery pack.
2. Properly position the guard (Fig. 2).

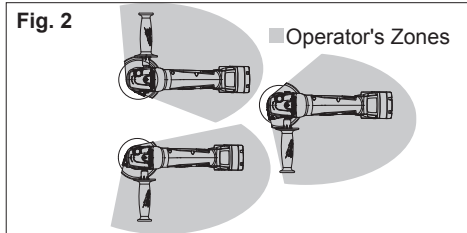

3. Wipe the flange, flange nut and spindle to remove dust and debris. Inspect the parts for damage. Replace if needed.
4. Place the flange on spindle, as shown.

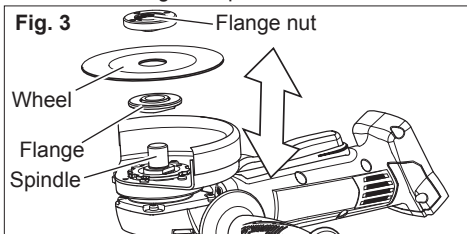

5. Place the selected wheel on the spindle and align it with the flange.
6. Position the flange nut over the spindle according to wheel thickness (Fig. 4).

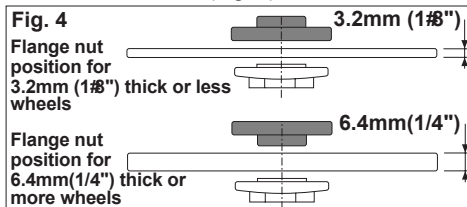

7. Press in the spindle lock button while turning the flange nut clockwise. Tighten securely using a spanner wrench.
8. To **remove** wheel, remove the battery pack and reverse the procedure.

OPERATION

! WARNING Always remove battery pack before changing or removing accessories. Only use accessories specifically recommended for this tool. Others may be hazardous.

! WARNING To reduce the risk of injury, wear safety goggles or glasses with side shields.

Controlled Start

The controlled start feature reduces the torque reaction "jerk" when its trigger is pulled.

Paddle Switch Operation

To **start** the tool, grasp the handle and side handle firmly. Pull the lock-off button back and squeeze the paddle switch.

To **stop** the tool, release the paddle switch. Make sure the tool comes to a complete stop before laying the tool down.

General Operation

1. If you have just installed an accessory or are beginning a period of work, test it by letting it spin for one minute before applying it to the workpiece. Out-of-balance or damaged accessories can mar workpiece, damage the tool, and cause stress that may cause accessory failure.
2. Use a clamp, vise or other practical means to hold your work, freeing both hands to control the tool.
3. Hold tool securely with both hands.
4. Start the tool.
5. Allow accessory to come to full speed before beginning work.
6. Control pressure and surface contact between accessory and workpiece. Too much pressure slows speed.
If the tool stalls, release the trigger to reset. Lighten pressure to avoid stalling.
7. When finished, turn off the tool and make sure it comes to a complete stop before laying it down.

USING CUT-OFF WHEELS

! WARNING A Type "1" guard must be installed when using a cut-off wheel to provide maximum protection for the operator if the wheel should break.

Type "1" Cut-Off Wheels are suited for small cut-off and shallow notching operations only. When using a cut-off wheel, hold the tool as shown, using only the edge of the wheel.

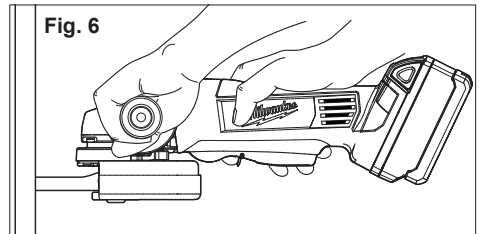

! WARNING Using the face of a Cut-Off Wheel (as in grinding) will cause the Wheel to crack and break, resulting in serious personal injury.

USING GRINDING WHEELS

⚠ WARNING To reduce the risk of injury, the operator should be instructed in the use, care and protection of grinding wheels.

Grinding Wheel Selection

Use grinding wheels, and accessories that are:

- correct size as written on tool's nameplate.
 - rated at or above the RPM listed on the tool's nameplate.
 - correct accessory, wheel type and grit for the job.
- Grinding is the cutting action of thousands of abrasive grains on the face of a grinding wheel. When grinding metals such as steel and iron, choose an aluminum oxide grinding wheel. Select a silicon carbide grinding wheel for stone and concrete. Use cotton reinforced wheels for non-ferrous metals. Type 27 Reinforced 3.2mm(1/8") thick or less Cut-Off Wheels are suited for small cut-off and shallow notching operations only. Always handle wheels carefully to avoid damage. Before installing any wheel, always inspect it for cracks. If wheel is cracked, discard it to prevent others from using it.

Care of Grinding & Cut-Off Wheels

Grinding/cut-off wheels should be protected from:

- wetness and extreme humidity
- any type of solvent
- extreme changes in temperature
- dropping and bumping

Grinding and cut-off wheels should be stored:

- in an organized way so wheels can be removed without disturbing or damaging other wheels
- with their safety information

Grinding and cut-off wheels should NOT be dropped, rolled or bumped.

Discard wheels that have been dropped, rolled, bumped, subjected to extreme changes in temperature, or come into contact with solvents or wetness.

Grinding

When grinding, hold tool at a 5° to 15° angle, using constant pressure for a uniform finish. Too great an angle causes concentrated pressure on small areas which may gouge or burn work surface.

Fig. 5

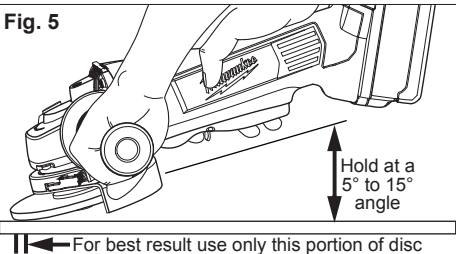

USING WIRE BRUSHES

⚠ WARNING Everyone in the area must wear protective clothing and safety goggles or face shields. Fatigued wires and residue will fly off the brush with considerable force, causing potential for serious injury.

Wire brushes are useful for removing rust, scale, burrs, weld slag, etc.

Always install wire cup brushes according to the accessory manufacturer's instructions.

Fig. 7 Wire Cup Brush

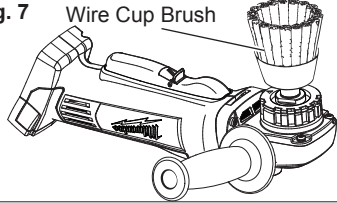

⚠ WARNING Because the wires on wire wheel brushes are directed towards the operator, a guard must be used to protect the operator when fatigued wires break.

When using a wire wheel brush, install guard according to "Installing/Removing Accessories".

Fig. 8 Guard

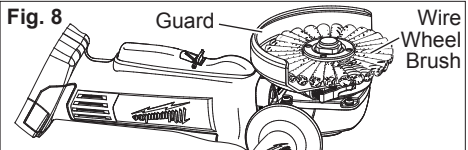

Test wheel for balance and loose or damaged wires by letting it spin for one minute before applying it to the workpiece. During this time, no one should stand in front of or in line with it.

Control pressure and surface contact between wheel and workpiece. Too much pressure causes over-bending of wires and heat build-up causing premature wire breaking, rapid dulling and reduced brush life. Instead of more pressure, try a wire wheel with more aggressive cutting action (increased wire size, decreased wire length or different brush type (knot type vs. crimped wire type)).

⚠ WARNING Never exceed Maximum Safe Operating Speed of brush. Do not use a damaged brush or one that is functioning improperly (throwing wires, out-of-balance, etc.). These conditions increase the possibility of further brush failure and possible injury. Discard and replace damaged brushes immediately.

USING SANDING DISCS

Sanding Disc Selection

Use sanding discs and accessories that are:

- correct size as written on tool's nameplate.
 - rated at or above the RPM listed on the tool's nameplate.
 - correct accessory, wheel type and grit for the job.
- Refer to the table below to select the correct type of sanding disc for your job. Generally, use 24 or 36 grit for heavy stock removal; 50, 60, or 80 grit for medium stock removal and 120 grit for finishing. Always begin with a coarse grit, using successively finer grits to obtain the desired finish.

Aluminum Oxide

For fast cutting, general purpose discs for most metal jobs. Best for cold-rolled steel, stainless steel or metals requiring tough, fast cutting, long lasting abrasives.

Aluminum Zirconia Bi-Cut

Unique grit pattern is arranged in clusters for faster stock removal and cleaning. Ideal for removing paint from cars, boats, etc. without clogging.

Ceramic

Lasts up to 3 times longer than Aluminum Oxide Discs. For general metal working. Ideal for tough jobs.

Installing Backing Pad and Sanding Discs

1. Remove the battery pack.
2. Wipe the accessories, disc nut and spindle to remove dust and debris. Inspect the parts for damage. Replace if needed.
3. Slip backing pad onto spindle with flat side away from gear case.
4. Place sanding disc on backing pad and secure assembly to spindle with disc nut.

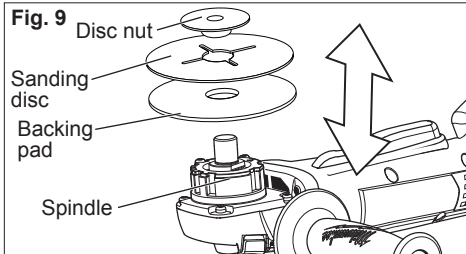

5. To tighten, press the spindle lock button while turning disc nut clockwise with the spanner wrench provided.
6. To remove backing pad and sanding disc, remove the battery pack and reverse the procedure.

Sanding

Hold tool at 5° to 15° angle to ensure proper sanding pressure and control. Too great an angle will result in too much pressure and could cause excessive wear to the disc and workpiece. Too small an angle will reduce control.

Use long, sweeping, side to side strokes, advancing forward to produce the desired finish.

Fig. 10

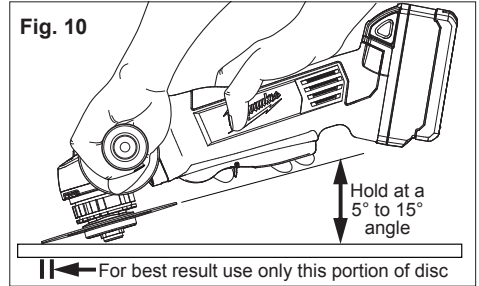

Cross Sanding

When finishing a surface that has been prepared by a coarse disc or wheel, sand at right angles to the strokes made by the coarser disc. Finishing marks left from previous sanding are easily seen and removed for a uniform finish. Failure to cross sand when changing from a coarse disc to a finishing disc may result in deep scratches and circular marks.

Removing Welds or Hammer Marks

When removing welds or hammer marks, limit coarse sanding to the immediate area. Use successively finer grits to smooth surface.

Finishing Metal

Constantly move across the surface. Work faster on curved surfaces where contact areas are smaller and pressure is greater. Flat areas may appear at the end of the stroke when pressure is too heavy. Ease up on pressure at end of each stroke and when reversing strokes.

Troubleshooting

Deep scratches and circular marks can result from:

- Using too coarse a grit
- Using a partially glazed disc
- Dirt or loose metal on the workpiece
- Failure to sand across the grain when changing from coarse to finishing discs
- Failure to use closed coated discs to reduce the problem of grains working loose and scratching the workpiece

Bluish discoloration of metal surface indicates:

- Excessive heat caused by circular motion in a small area
- Excessive pressure
- Use of worn out or glazed discs

MAINTENANCE

 **WARNING** To reduce the risk of injury, always unplug the charger and remove the battery pack from the charger or tool before performing any maintenance. Never disassemble the tool, battery pack or charger. Contact a **MILWAUKEE®** service facility for ALL repairs.

Maintaining Tool

Keep your tool, battery pack and charger in good repair by adopting a regular maintenance program. After six months to one year, depending on use, return the tool, battery pack and charger to your authorised **MILWAUKEE®** dealer for repairs.

- Lubrication
- Mechanical inspection and cleaning (gears, spindles, bearings, housing, etc.)
- Electrical inspection (battery pack, charger, motor)
- Testing to assure proper mechanical and electrical operation

If the tool does not start or operate at full power with a fully charged battery pack, clean the contacts on the battery pack. If the tool still does not work properly, return the tool, charger and battery pack, to your authorised **MILWAUKEE®** dealer for repairs.

 **WARNING** To reduce the risk of personal injury and damage, never immerse your tool, battery pack or charger in liquid or allow a liquid to flow inside them.

Cleaning

Clean dust and debris from charger and tool vents. Keep tool handles clean, dry and free of oil or grease. Use only mild soap and a damp cloth to clean the tool, battery pack and charger since certain cleaning agents and solvents are harmful to plastics and other insulated parts. Some of these include gasoline, turpentine, lacquer thinner, paint thinner, chlorinated cleaning solvents, ammonia and household detergents containing ammonia. Never use flammable or combustible solvents around tools.

Repairs

For repairs, return the tool, battery pack and charger to your authorised **MILWAUKEE®** dealer.

ACCESSORIES

 **WARNING** Always remove battery pack before changing or removing accessories. Only use accessories specifically recommended for this tool. Others may be hazardous.

WARRANTY - AUSTRALIA and NEW ZEALAND

Please refer to Australian and New Zealand warranty supplied with tool. This warranty applies only to product sold in Australia and New Zealand.

SERVICE - AUSTRALIA and NEW ZEALAND

MILWAUKEE® prides itself in producing a premium quality product that is Nothing But Heavy Duty®. Your satisfaction with our products is very important to us! If you encounter any problems with the operation of this tool, please contact your authorised **MILWAUKEE®** dealer.

For a list of **MILWAUKEE®** dealers, guarantee or service agents please contact **MILWAUKEE®** Customer Service or visit our website.

(Australia Toll Free Telephone Number 1300 645 928)

(New Zealand Toll Free Telephone Number 0800 645 928)

or visit www.milwaukeetools.com.au / www.milwaukeetools.co.nz.

Milwaukee Electric Tool Corporation

13135 West Lisbon Road, Brookfield, Wisconsin U.S.A. 53005

Milwaukee Tool (Australia)

21 Kelletts Road, Rowville, VIC 3178
Melbourne, Australia

Milwaukee Tool (New Zealand)

274 Church Street, Penrose,
Auckland, 1061, New Zealand

Designed by Milwaukee Electric Tool Corp.

Professionally Made in China for Milwaukee Tool (Australia) / Milwaukee Tool (New Zealand)

Printed in China