

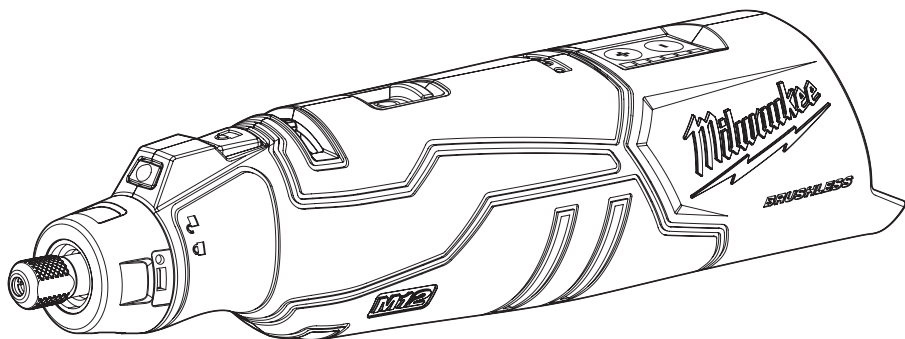



## OPERATOR'S MANUAL



Cat. No.  
**M12 BLROT**

**M12™ BRUSHLESS ROTARY TOOL**

 **WARNING**

 To reduce the risk of injury, user must read and understand operator's manual.

## GENERAL POWER TOOL SAFETY WARNINGS

**WARNING** Read all safety warnings, instructions, illustrations and specifications provided with this power tool. Failure to follow all instructions listed below may result in electric shock, fire and/or serious injury. **Save all warnings and instructions for future reference.** The term "power tool" in the warnings refers to your mains-operated (corded) power tool or battery-operated (cordless) power tool.

### WORK AREA SAFETY

- **Keep work area clean and well lit.** Cluttered or dark areas invite accidents.
- **Do not operate power tools in explosive atmospheres, such as in the presence of flammable liquids, gases or dust.** Power tools create sparks which may ignite the dust or fumes.
- **Keep children and bystanders away while operating a power tool.** Distractions can cause you to lose control.

### ELECTRICAL SAFETY

- **Power tool plugs must match the outlet. Never modify the plug in any way. Do not use any adapter plugs with earthed (grounded) power tools.** Unmodified plugs and matching outlets will reduce risk of electric shock.
- **Avoid body contact with earthed or grounded surfaces, such as pipes, radiators, ranges and refrigerators.** There is an increased risk of electric shock if your body is earthed or grounded.
- **Do not expose power tools to rain or wet conditions.** Water entering a power tool will increase the risk of electric shock.
- **Do not abuse the cord. Never use the cord for carrying, pulling or unplugging the power tool. Keep cord away from heat, oil, sharp edges or moving parts.** Damaged or entangled cords increase the risk of electric shock.
- **When operating a power tool outdoors, use an extension cord suitable for outdoor use.** Use of a cord suitable for outdoor use reduces the risk of electric shock.
- **If operating a power tool in a damp location is unavoidable, use a residual current device (RCD) protected supply.** Use of a RCD reduces the risk of electric shock.

### PERSONAL SAFETY

- **Stay alert, watch what you are doing and use common sense when operating a power tool. Do not use a power tool while you are tired or under the influence of drugs, alcohol or medication.** A moment of inattention while operating power tools may result in serious personal injury.
- **Use personal protective equipment. Always wear eye protection.** Protective equipment such as a dust mask, non-skid safety shoes, hard hat or hearing protection used for appropriate conditions will reduce personal injuries.
- **Prevent unintentional starting. Ensure the switch is in the off-position before connecting to power source and/or battery pack, picking up or carrying the tool.** Carrying power tools with your finger on the switch or energising power tools that have the switch on invites accidents.

- **Remove any adjusting key or wrench before turning the power tool on.** A wrench or a key left attached to a rotating part of the power tool may result in personal injury.
- **Do not overreach. Keep proper footing and balance at all times.** This enables better control of the power tool in unexpected situations.
- **Dress properly. Do not wear loose clothing or jewellery. Keep your hair and clothing away from moving parts.** Loose clothes, jewellery or long hair can be caught in moving parts.
- **If devices are provided for the connection of dust extraction and collection facilities, ensure these are connected and properly used.** Use of dust collection can reduce dust-related hazards.
- **Do not let familiarity gained from frequent use of tools allow you to become complacent and ignore tool safety principles.** A careless action can cause severe injury within a fraction of a second.

### POWER TOOL USE AND CARE

- **Do not force the power tool. Use the correct power tool for your application.** The correct power tool will do the job better and safer at the rate for which it was designed.
- **Do not use the power tool if the switch does not turn it on and off.** Any power tool that cannot be controlled with the switch is dangerous and must be repaired.
- **Disconnect the plug from the power source and/or remove the battery pack, if detachable, from the power tool before making any adjustments, changing accessories, or storing power tools.** Such preventive safety measures reduce the risk of starting the power tool accidentally.
- **Store idle power tools out of the reach of children and do not allow persons unfamiliar with the power tool or these instructions to operate the power tool.** Power tools are dangerous in the hands of untrained users.
- **Maintain power tools and accessories. Check for misalignment or binding of moving parts, breakage of parts and any other condition that may affect the power tool's operation. If damaged, have the power tool repaired before use.** Many accidents are caused by poorly maintained power tools.
- **Keep cutting tools sharp and clean.** Properly maintained cutting tools with sharp cutting edges are less likely to bind and are easier to control.
- **Use the power tool, accessories and tool bits etc. in accordance with these instructions, taking into account the working conditions and the work to be performed.** Use of the power tool for operations different from those intended could result in a hazardous situation.
- **Keep handles and grasping surfaces dry, clean and free from oil and grease.** Slippery handles and grasping surfaces do not allow for safe handling and control of the tool in unexpected situations.

### BATTERY TOOL USE AND CARE

- **Recharge only with the charger specified by the manufacturer.** A charger that is suitable for one type of battery pack may create a risk of fire when used with another battery pack.
- **Use power tools only with specifically designated battery packs.** Use of any other battery packs may create a risk of injury and fire.

- When battery pack is not in use, keep it away from other metal objects, like paper clips, coins, keys, nails, screws or other small metal objects, that can make a connection from one terminal to another. Shorting the battery terminals together may cause burns or a fire.
- Under abusive conditions, liquid may be ejected from the battery; avoid contact. If contact accidentally occurs, flush with water. If liquid contacts eyes, additionally seek medical help. Liquid ejected from the battery may cause irritation or burns.
- Do not use a battery pack or tool that is damaged or modified. Damaged or modified batteries may exhibit unpredictable behaviour resulting in fire, explosion or risk of injury.
- Do not expose a battery pack or tool to fire or excessive temperature. Exposure to fire or temperature above 130°C (265°F) may cause explosion.
- Follow all charging instructions and do not charge the battery pack or tool outside the temperature range specified in the instructions. Charging improperly or at temperatures outside the specified range may damage the battery and increase the risk of fire.
- Do not use a damaged accessory. Before each use inspect the accessory such as abrasive wheels for chips and cracks, backing pad for cracks, tear or excess wear, wire brush for loose or cracked wires. If power tool or accessory is dropped, inspect for damage or install an undamaged accessory. After inspecting and installing an accessory, position yourself and bystanders away from the plane of the rotating accessory and run the power tool at maximum no-load speed for one minute. Damaged accessories will normally break apart during this test time.
- Wear personal protective equipment. Depending on application, use face shield, safety goggles or safety glasses. As appropriate, wear dust mask, hearing protectors, gloves and workshop apron capable of stopping small abrasive or workpiece fragments. The eye protection must be capable of stopping flying debris generated by various operations. The dust mask or respirator must be capable of filtering particles generated by your operation. Prolonged exposure to high intensity noise may cause hearing loss.
- Keep bystanders a safe distance away from work area. Anyone entering the work area must wear personal protective equipment. Fragments of workpiece or of a broken accessory may fly away and cause injury beyond immediate area of operation.

### SERVICE

- Have your power tool serviced by a qualified repair person using only identical replacement parts. This will ensure that the safety of the power tool is maintained.
- Never service damaged battery packs. Service of battery packs should only be performed by the manufacturer or authorised service providers.

### SPECIFIC SAFETY RULES FOR ROTARY TOOL

#### Safety Warnings Common for Grinding, Sanding, Wire Brushing, Polishing or Abrasive Cutting-Off Operations:

- This power tool is intended to function as a grinder, sander, wire brush, polisher or cut-off tool. Read all safety warnings, instructions, illustrations and specifications provided with this power tool. Failure to follow all instructions listed below may result in electric shock, fire and/or serious injury.
- Do not use accessories which are not specifically designed and recommended by the tool manufacturer. Just because the accessory can be attached to your power tool, it does not assure safe operation.
- The rated speed of the accessory must be at least equal to the maximum speed marked on the power tool. Accessories running faster than their RATED SPEED can break and fly apart.
- The outside diameter and the thickness of your accessory must be within the capacity rating of your power tool. Incorrectly sized accessories cannot be adequately guarded or controlled.
- The arbour size of wheels, flanges, backing pads or any other accessory must properly fit the spindle of the power tool. Accessories with arbour holes that do not match the mounting hardware of the power tool will run out of balance, vibrate excessively and may cause loss of control.
- Do not run the power tool while carrying it at your side. Accidental contact with the spinning accessory could snag your clothing, pulling the accessory into your body.
- Regularly clean the power tool's air vents. The motor's fan will draw the dust inside the housing and excessive accumulation of powdered metal may cause electrical hazards.
- Do not operate the power tool near flammable materials. Sparks could ignite these materials.
- Do not use accessories that require liquid coolants. Using water or other liquid coolants may result in electrocution or shock.
- Allow brushes to run at operating speed for at least one minute before using them. During this time no one is to stand in front or in line with the brush. Loose bristles or wires will be discharged during the run-in time.
- Direct the discharge of the spinning wire brush away from you. Small particles and tiny wire fragments may be discharged at high velocity during the use of these brushes and may become imbedded in your skin.

#### Kickback and Related Warnings

Kickback is a sudden reaction to a pinched or snagged rotating wheel, backing pad, brush or any other accessory. Pinching or snagging causes

rapid stalling of the rotating accessory which in turn causes the uncontrolled power tool to be forced in the direction opposite of the accessory's rotation at the point of the binding.

For example, if an abrasive wheel is snagged or pinched by the workpiece, the edge of the wheel that is entering into the pinch point can dig into the surface of the material causing the wheel to climb out or kick out. The wheel may either jump toward or away from the operator, depending on direction of the wheel's movement at the point of pinching. Abrasive wheels may also break under these conditions.

Kickback is the result of power tool misuse and/or incorrect operating procedures or conditions and can be avoided by taking proper precautions as given below.

- **Maintain a firm grip on the power tool and position your body and arm to allow you to resist kickback forces.** The operator can control torque reactions or kickback forces, if proper precautions are taken.
- **Never place your hand near the rotating accessory.** Accessory may kickback over your hand.
- **Do not position your body in the area where power tool will move if kickback occurs.** Kickback will propel the tool in direction opposite to the wheel's movement at the point of snagging.
- **Use special care when working corners, sharp edges etc. Avoid bouncing and snagging the accessory.** Corners, sharp edges or bouncing have a tendency to snag the rotating accessory and cause loss of control or kickback.
- **Do not attach a toothed saw blade.** Such blades create frequent kickback and loss of control.
- **Always feed the bit into the material in the same direction as the cutting edge is exiting from the material (which is the same direction as the chips are thrown).** Feeding the tool in the wrong direction causes the cutting edge of the bit to climb out of the work and pull the tool in the direction of this feed.
- **When using rotary files, cut-off wheels, high-speed cutters or tungsten carbide cutters, always have the work securely clamped.** These wheels will grab if they become slightly canted in the groove, and can kickback. When a cut-off wheel grabs, the wheel itself usually breaks. When a rotary file, high-speed cutter or tungsten carbide cutter grabs, it may jump from the groove and you could lose control of the tool.

#### **Safety Warnings Specific for Grinding and Abrasive Cutting-Off Operations:**

- **Use only wheel types that are recommended for your power tool and only for recommended applications.** For example: do not grind with the side of a cut-off wheel. Abrasive cut-off wheels are intended for peripheral grinding, side forces applied to these wheels may cause them to shatter.
- **For threaded abrasive cones and plugs use only undamaged wheel mandrels with an unrelieved shoulder flange that are of correct size and length.** Proper mandrels will reduce the possibility of breakage.
- **Do not "jam" the cut-off wheel or apply excessive pressure. Do not attempt to make an excessive depth of cut.** Overstressing the wheel increases the loading and susceptibility to twisting or binding of the wheel in the cut and the possibility of kickback or wheel breakage.

- **Do not position your hand in line with and behind the rotating wheel.** When the wheel, at the point of operation, is moving away from your hand, the possible kickback may propel the spinning wheel and the spinning wheel directly at you.
- **When wheel is pinched, snagged or when interrupting a cut for any reason, switch off the power tool and hold the power tool motionless until the wheel comes to a complete stop. Never attempt to remove the cut-off wheel from the cut while the wheel is in motion otherwise kickback may occur.** Investigate and take corrective action to eliminate the cause of wheel binding.
- **Do not restart the cutting operation in the workpiece. Let the wheel reach full speed and carefully re-enter the cut.** The wheel may bind, walk up or kickback if the power tool is restarted in the workpiece.
- **Support panels or any oversized workpiece to minimize the risk of wheel pinching and kickback.** Large workpieces tend to sag under their own weight. Supports must be placed under the workpiece near the line of cut and near the edge of the workpiece on both sides of the wheel.
- **Use extra caution when making a "pocket cut" into existing walls or other blind areas.** The protruding wheel may cut gas or water pipes, electrical wiring or objects that can cause kickback.

#### **Additional Safety Warnings**

- **The arbour size of wheels, sanding drum or any other accessory must properly fit the spindle or collet of the power tool.** Accessories that do not match the mounting hardware of the power tool will run out of balance, vibrate excessively and may cause loss of control.
- **Mandrel mounted wheels, sanding drums, cutters or other accessories must be fully inserted into the collet or chuck. The "overhang" or the length of the mandrel from the wheel to the collet must be minimal.** If the mandrel is insufficiently held and/or the overhang of the wheel is too long, the mounted wheel may become loose and ejected at high velocity.
- **After changing the bits or making any adjustments, make sure the collet nut, chuck or any other adjustment devices are securely tightened.** Loose adjustment devices can unexpectedly shift, causing loss of control, loose rotating components will be violently thrown.

**⚠WARNING** To reduce the risk of injury, when working in dusty situations, wear appropriate respiratory protection or use a suitable dust extraction solution. To reduce the risk of injury, when working in dusty situations, wear appropriate respiratory protection or use a suitable dust extraction solution.

• **Always use common sense and be cautious when using tools.** It is not possible to anticipate every situation that could result in a dangerous outcome. Do not use this tool if you do not understand these operating instructions or you feel the work is beyond your capability; contact MILWAUKEE® Tool or a trained professional for additional information or training.

• **Maintain labels and nameplates.** These carry important information. If unreadable or missing, contact a MILWAUKEE® service facility for a replacement.

**WARNING** Some dust created by power sanding, sawing, grinding, drilling, and other construction activities contains chemicals known to cause cancer, birth defects or other reproductive harm. Some examples of these chemicals are:

- lead from lead-based paint
- crystalline silica from bricks and cement and other masonry products, and
- arsenic and chromium from chemically-treated lumber.

Your risk from these exposures varies, depending on how often you do this type of work. To reduce your exposure to these chemicals: work in a well ventilated area, and work with approved safety equipment, such as those dust masks that are specially designed to filter out microscopic particles.

**READ AND SAVE ALL INSTRUCTIONS FOR FUTURE USE**

**ADDITIONAL BATTERY SAFETY RULES**

**WARNING** To reduce the risk of fire, personal injury, and product damage due to a short circuit, never immerse your tool, battery pack or charger in fluid or allow a fluid to flow inside them. Corrosive or conductive fluids, such as seawater, certain industrial chemicals, and bleach or bleach-containing products, etc., can cause a short circuit.

**WARNING** Do not charge non-rechargeable batteries.

**SYMBOLGY**

 Volts

 Direct Current

$n_0$  XXXX min<sup>-1</sup> No Load Revolutions per Minute (RPM)

 Read operator's manual.

 Wear safety glasses.

 Wear dust mask.

 Regulatory Compliance Mark (RCM). This product meets applicable regulatory requirements.

Do not dispose of electric tools together with household waste material. Electric tools and electronic equipment that have reached the end of their life must be collected separately and returned to an environmentally compatible recycling facility.



**SPECIFICATIONS**

Cat. No. ....	<b>M12 BLROT</b>
Volts.....	12 V DC
Battery Type .....	M12™
Charger Type.....	M12™
No Load RPM.....	5,000 - 27,500
Collet .....	3.2 mm (1/8")*
Max Accessory Diameter.....	55 mm
Recommended Ambient Operating Temperature.....	-17°C to 51°C

\* Also accepts standard collet sizes 0.8 mm (1/32"), 1.6 mm (1/16"), 2.4 mm (3/32") (sold separately)

**FUNCTIONAL DESCRIPTION**

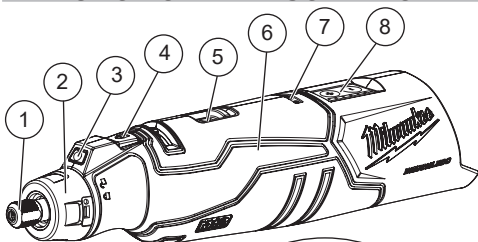

1. Collet nut
2. Nose collar
3. LED
4. Spindle lock
5. ON/OFF switch
6. Handle
7. Fuel gauge
8. Speed selector

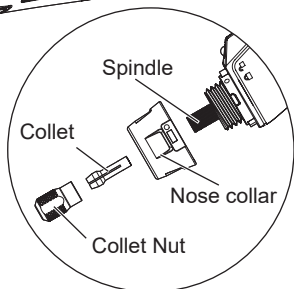

## ASSEMBLY

**⚠WARNING** Recharge only with the charger specified for the battery. For specific charging instructions, read the operator's manual supplied with your charger and battery.

### Inserting/Removing the Battery

To insert the battery, slide the pack into the body of the tool. Make sure it latches securely into place.

**⚠WARNING** Only use accessories specifically recommended for this tool.

Others may be hazardous.

To remove the battery, push in the release buttons and pull the battery pack away from the tool.

**⚠WARNING** Always remove the battery pack any time the tool is not in use.

Only use accessories with Maximum Safe Operating Speed rated at least equal to the maximum speed marked on the power tool. This speed is based on the strength of the accessory, allowing for a reasonable measure of safety. It is not meant to imply a best or most efficient operating speed. Do not exceed the Maximum Safe Operating Speed.

To reduce the risk of injury, always clean mandrels before inserting them into the collet and securely tighten the collet nut and. Otherwise the high-speed rotation of the tool could force the accessory to fly out of the collet. Everyone in the area must wear protective clothing and safety goggles or face shields. Damaged accessories may fly apart with considerable force, causing potential for serious injury.

### Installing Accessories

1. **⚠WARNING** Remove battery to avoid starting the tool.
2. To remove the nose cover, twist to the UNLOCK position and pull away from the tool. The nose cover can be used for toolless accessory changing.

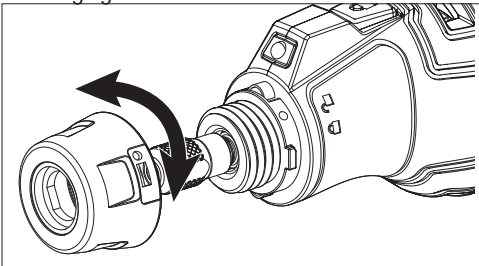

3. Remove dust and debris from the collet, collet nut, and accessory shank.

4. Insert the collet into the spindle.

5. Loosely screw the collet nut onto the spindle.

6. Insert the accessory shank into the collet at least 19 mm (3/4").

7. Press in the spindle lock button and tighten the collet nut securely using the nose cover (or a 9.5 mm (3/8") collet wrench).

**NOTE:** Do not tighten the collet nut without an accessory installed. This could damage the collet.

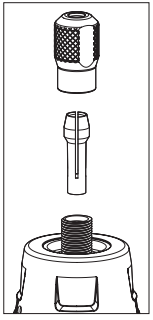

**⚠WARNING** To reduce the risk of injury, the operator should be instructed in the use, care and protection of accessories.

### Typical Applications

A large variety of accessories are available for applications such as grinding, sanding, and cutting.

#### Grinding/Sanding

Use sanding and grinding accessories that are:

- less than 55 mm in diameter.
- correct accessory type and grit for the job.
- rated at or above the RPM listed on the tool's nameplate.

#### Wheel Brushes

Wire wheel brushes are useful for removing rust, scale, burrs, weld slag, etc. A wide variety of wire brushes are available for many applications. When applying brush to work, avoid using too much pressure. This causes over-bending of wires and heat build-up resulting in premature wire breakage, rapid dulling and reduced brush life. Instead of using more pressure, try a wire wheel brush with more aggressive cutting action (increased wire size, decreased wire length or different brush type, i.e. knot type instead of crimped wire type).

#### Cutting

Always handle cutting wheels carefully to avoid damage. Before installing any wheel, always inspect it for cracks. If wheel is cracked, discard it to prevent others from using it. Cutting wheels should be protected from:

- wetness and extreme humidity
- any type of solvent
- extreme changes in temperature
- dropping and bumping

If a cutting wheel encounters any of these situations, discard the wheel immediately.

## OPERATION

**⚠WARNING** Always use personal protective equipment. Always wear eye protection marked to comply with AS/NZS 1337.1.

When working in dusty situations, wear appropriate respiratory protection or use a suitable dust extraction solution.

### Fuel Gauge

To determine the amount of charge left in the battery, turn the tool ON. The fuel gauge will light up for 2-3 seconds. When less than 10% of charge is left, 1 light on the fuel gauge will flash 4 times.

To signal the end of charge, 1 light on the fuel

gauge will flash 8 times and the tool will not run. Charge the battery pack.

If the battery becomes too hot, the fuel gauge lights will flash and the tool will not run. Allow the battery to cool down.

### Selecting the Speed

To set the speed, use the speed selector buttons +/- to cycle from the lowest speed (5,000 RPM) to the highest speed (27,500 RPM). Each LED can display two speeds. Odd speeds (1, 3, 5, 7, 9, 11) display initially as solid. Even speeds (2, 4, 6, 8, 10, 12) display initially as blinking, then go solid. The LEDs will light as you increase/decrease the speed setting.

**NOTE:** The tool will default to the selected speed the next time it is turned on.

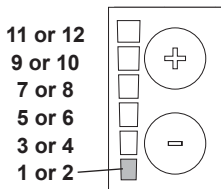

Speed Setting	RPM	Speed Setting	RPM
1	5,000	7	17,250
2	7,050	8	19,300
3	9,100	9	21,350
4	11,100	10	23,400
5	13,200	11	25,450
6	15,200	12	27,500

### Using the Rotary Tool

Determine the best grip for your job. The rotary tool can be held like a pencil for fine work, or gripped around the body when less precision is needed.

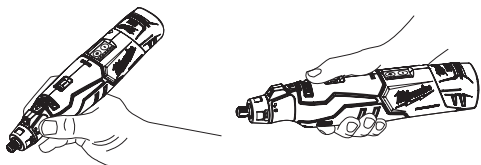

Practice on scrap material to determine the best speed, correct accessory, and get a feel for the job. Do not press the accessory into the workpiece. Little or no operator force should be needed when the correct accessory and speed are used. Touch the accessory to the workpiece and guide it over the work, making multiple passes when necessary.

Move the tool in the same direction as the bit is spinning (as indicated by the arrow near the front of the tool). Moving the tool in the opposite direction can cause the tool to kickback, ending up in loss of control and damage to the workpiece.

**WARNING** Everyone in the area must wear protective clothing and safety goggles or face shields. Damaged accessories may fly apart with considerable force, causing potential for serious injury.

### Starting/Stopping

1. Use a clamp, vise or other practical means to hold your work, freeing both hands to control your tool.
2. To **start** the tool, grasp the tool and slide the switch forward to the **ON** (I) position.
3. Allow the tool to come to full speed before beginning work.
4. Use the speed selector buttons to cycle from the lowest speed (5,000 RPM) to the highest speed (27,500 RPM).
5. To **stop** the tool, slide the switch back to the **OFF** (0) position. Make sure the tool comes to a complete stop before laying the tool down.

**NOTE:** Do not press the spindle lock button while tool is running or the accessory is moving. This could damage the tool.

### MAINTENANCE

**WARNING** To reduce the risk of injury, always unplug the charger and remove the battery pack from the charger or tool before performing any maintenance. Never disassemble the tool, battery pack or charger. Contact a **MILWAUKEE**® service facility for ALL repairs.

### Maintaining Tool

Keep your tool, battery pack and charger in good repair by adopting a regular maintenance program. Inspect your tool for issues such as undue noise, misalignment or binding of moving parts, breakage of parts, or any other condition that may affect the tool operation. Return the tool, battery pack, and charger to a **MILWAUKEE**® service facility for repair. If the tool does not start or operate at full power with a fully charged battery pack, clean the contacts on the battery pack. If the tool still does not work properly, return the tool, charger and battery pack, to a **MILWAUKEE**® service facility for repairs.

### Cleaning

Clean dust and debris from vents. Keep handles clean, dry and free of oil or grease. Use only mild soap and a damp cloth to clean, since certain cleaning agents and solvents are harmful to plastics and other insulated parts. Some of these include petrol, turpentine, lacquer thinner, paint thinner, chlorinated cleaning solvents, ammonia and household detergents containing ammonia. Never use flammable or combustible solvents around tools.

### Repairs

For repairs, return the tool, battery pack and charger to the nearest authorised service centre.

### ACCESSORIES

**WARNING** Use only recommended accessories. Others may be hazardous.

## **WARRANTY - AUSTRALIA and NEW ZEALAND**

Please refer to Australian and New Zealand warranty supplied with tool. This warranty applies only to product sold by authorised dealers in Australia and New Zealand.

## **SERVICE - AUSTRALIA and NEW ZEALAND**

**MILWAUKEE®** prides itself in producing a premium quality product that is Nothing But Heavy Duty™. Your satisfaction with our products is very important to us! If you encounter any problems with the operation of this tool, please contact your authorised **MILWAUKEE®** dealer.

For a list of **MILWAUKEE®** dealers, guarantee or service agents please contact **MILWAUKEE®** Customer Service or visit our website.

(Australia Toll Free Telephone Number 1300 645 928)

(New Zealand Toll Free Telephone Number 0800 645 928)

or visit [milwaukeetool.com.au/milwaukeetool.co.nz](http://milwaukeetool.com.au/milwaukeetool.co.nz).

### **Milwaukee Electric Tool Corporation**

13135 West Lisbon Road, Brookfield, Wisconsin U.S.A. 53005

#### **Milwaukee Tool (Australia)**

26 - 40 Nina Link, Dandenong South,  
Victoria, 3175, Australia

#### **Milwaukee Tool (New Zealand)**

274 Church Street, Penrose,  
Auckland, 1061, New Zealand

DESIGNED BY MILWAUKEE ELECTRIC TOOL CORP.  
PROFESSIONALLY MADE IN CHINA  
PRINTED IN CHINA