

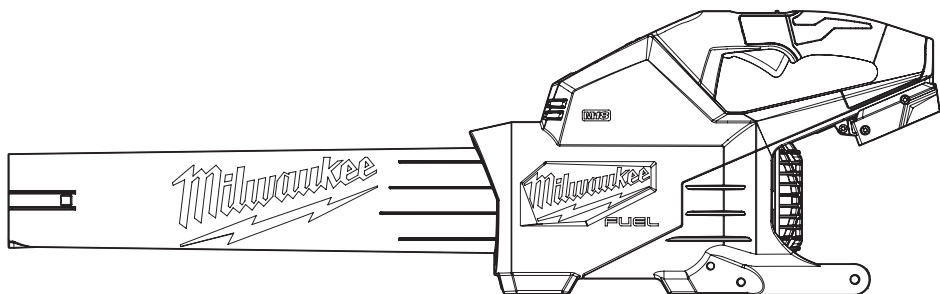



OPERATOR'S MANUAL



Cat. No.
M18 F2BL

M18 FUEL™ DUAL BATTERY BLOWER

 **WARNING**

 To reduce the risk of injury, user must read and understand operator's manual.

IMPORTANT SAFETY INSTRUCTIONS

⚠WARNING Read all safety warnings, instructions, illustrations and specifications provided with this power tool. Failure to follow all instructions listed below may result in electric shock, fire and/or serious injury. **Save all warnings and instructions for future reference.**

- This appliance is not intended for use by persons (including children) with reduced physical, sensory or mental capabilities, or lack of experience and knowledge, unless they have been given supervision or instruction concerning use of the appliance by a person responsible for their safety.
- Children should be supervised to ensure that they do not play with the appliance.

WORK AREA SAFETY

- **Do not use in the presence of explosive dust, liquids or vapours. Power tools have motors and other parts that can produce sparks during normal use.** Do not use within 10 m of areas where explosive materials may be present (such as gasoline pumps and places where liquids like paint thinners, cleaners, solvents, etc. are stored).
- **Do not use where oxygen or anesthetics are used.**
- **Use extra care when using on stairs. Do not over-reach. Keep proper footing and balance at all times. Keep work area clean and well lit.** This enables better control of the tool in unexpected situations.
- **Avoid dangerous environmental conditions. To reduce the risk of electric shock, do not expose to rain. Store tool indoors.**
- **Inspect the area before using the power tool.** Remove all debris and hard objects such as rocks, glass, wire, etc. that can ricochet, be thrown, or otherwise cause injury or damage during operation.

PERSONAL SAFETY

- **Stay alert, watch what you are doing and use common sense when operating a power tool. Do not use a power tool while you are tired or under the influence of drugs, alcohol or medication.** A moment of inattention while operating power tools may result in serious personal injury.
- **Always wear eye protection. Use of this tool can result in foreign objects being blown into eyes, which can result in eye damage.**
- **Wear a face or dust mask** when working in dust situations. Dust particles can harm your lungs.
- **Use personal protective equipment.** Protective equipment such as hearing protection, protective clothing, and non-skid safety shoes used for appropriate conditions will reduce personal injuries.
- **Dress properly. Do not wear loose clothing or jewellery. Keep your hair and clothing away from moving parts.** Loose clothes, jewellery or long hair can be caught in moving parts.

- **Do not point tool at self or bystanders. Keep bystanders 15 m away during use.** Objects may be thrown or ricochet in all directions.
- **Do not let familiarity gained from frequent use of tools allow you to become complacent and ignore tool safety principles.** A careless action can cause severe injury within a fraction of a second.

POWER TOOL USE AND CARE

- **Use the power tool, accessories, etc. in accordance with these instructions, taking into account the working conditions and the work to be performed.** Use of the power tool for operations different from those intended could result in a hazardous situation.
- **Prevent unintentional starting. Ensure the switch is in the off-position before connecting to power source and/or battery pack, picking up or carrying the tool.** Carrying power tools with your finger on the switch or energising power tools that have the switch on invites accidents.
- **Use the correct power tool for your application.** The correct power tool will do the job better and safer at the rate for which it was designed.
- **Use only as described in this manual.** Use only manufacturer's recommended attachments.
- **Do not point tool at anything that is burning or smoking** such as cigarettes, matches, or hot ashes.
- **To reduce the risk of health hazards from vapours or dust, do not use tool near tool toxic, carcinogenic or other hazardous materials** such as asbestos, arsenic, barium, beryllium, lead, pesticides or other health endangering materials.

⚠WARNING Some dust created by power sanding, sawing, grinding, drilling, and other construction activities contains chemicals known to cause cancer, birth defects or other reproductive harm. Some examples of these chemicals are:

- lead from lead-based paint
 - crystalline silica from bricks and cement and other masonry products, and
 - arsenic and chromium from chemically-treated lumber.
- Your risk from these exposures varies, depending on how often you do this type of work. To reduce your exposure to these chemicals: work in a well ventilated area, and work with approved safety equipment, such as those dust masks that are specially designed to filter out microscopic particles.
- **Do not use power tool if the switch does not turn it on and off.** Any power tool that cannot be controlled with the switch is dangerous and must be repaired.
 - **Do not put hands or objects into openings.** Do not use with any opening blocked; keep free of dust, lint, hair, and anything else that may reduce air flow.
 - **Keep handles and grasping surfaces dry, clean and free from oil and grease.** Slippery handles and grasping surfaces do not allow for safe handling and control of the tool in unexpected situations.
 - **Maintain power tools and accessories. Check for misalignment or binding of moving parts, breakage of parts and any other condition that may affect the power tool's operation. If damaged, have the power tool repaired before use.** Many accidents are caused by poorly maintained power tools.

BATTERY PACK USE AND CARE

- Remove the battery packs from the power tool before making any adjustments, changing accessories, storing, or any time the power tool is not in use. Such preventive safety measures reduce the risk of starting the power tool accidentally.
- Turn off power tool before removing battery packs.
- Do not handle battery packs, tool, or charger (including charger plug and terminals) with wet hands.
- Before using the battery packs or charger read the operator's manuals, and any labels on the battery packs, charger and tool.
- Recharge only with the charger specified by the manufacturer. A charger that is suitable for one type of battery packs may create a risk of fire when used with another battery packs.
- Use tool only with specifically designated battery packs. Use of any other battery packs may create a risk of injury and fire.
- When battery packs are not in use, keep them away from other metal objects like paper clips, coins, keys, nails, screws, or other small metal objects that can make a connection from one terminal to another. Shorting the battery terminals together may cause burns or a fire.
- Under abusive conditions, liquid may be ejected from the battery; avoid contact. If contact accidentally occurs, flush with water. If liquid contacts eyes, additionally seek medical help. Liquid ejected from the battery may cause irritation or burns. It may be toxic if swallowed.
- Do not use damaged battery pack or tool. If battery pack or appliance are not working as they should, have been dropped, damaged, left outdoors, or dropped into water, return them to a service centre.
- Do not modify or attempt to repair the tool or battery pack.
- Do not expose a battery pack or tool to fire or excessive temperature. Exposure to fire or temperature above 130°C (265°F) may cause explosion.
- Follow all charging instructions and do not charge the battery packs or tool outside the temperature range specified in the instructions. Charging improperly or at temperatures outside the specified range may damage the battery and increase the risk of fire.

SERVICE

- Have your power tool serviced by a qualified repair person using only identical replacement parts. This will ensure that the safety of the power tool is maintained.
- Never service damaged battery packs. Service of battery packs should only be performed by the manufacturer or authorised service providers.
- Maintain labels and nameplates. These carry important information. If unreadable or missing, contact a MILWAUKEE® service facility for a replacement.

READ AND SAVE ALL INSTRUCTIONS FOR FUTURE USE

ADDITIONAL BATTERY SAFETY RULES

AWARNING To reduce the risk of fire, personal injury, and product damage due to a short circuit, never immerse your tool, battery pack or charger in fluid or allow a fluid to flow inside them. Corrosive or conductive fluids, such as seawater, certain industrial chemicals, and bleach or bleach-containing products, etc., can cause a short circuit.

AWARNING Do not charge non-rechargeable batteries.

SYMBOLGY

 Volts

 Direct Current

n, XXXX min⁻¹ No Load Revolutions per Minute (RPM)

 Safety Alert Symbol

 Read Operator's Manual

 Always wear eye protection, hearing protection, and protective clothing and footwear.

 Sound Pressure Level

 Do not use in rain or wet locations. Electric shock could occur.

 Keep bystanders 15 m away during use

 Do not point tool at self or bystanders. Objects may be thrown or ricochet in all directions.

 Do not put hands or objects into openings. Laceration can occur.

 Keep hair contained. It can be pulled into moving parts.

 Do not wear loose clothing or jewellery. It can be pulled into moving parts.

 Regulatory Compliance Mark (RCM). This product meets applicable regulatory requirements.

 Do not dispose of electric tools together with household waste material. Electric tools and electronic equipment that have reached the end of their life must be collected separately and returned to an environmentally compatible recycling facility.

FUNCTIONAL DESCRIPTION

1. Flat nozzle
2. Tapered nozzle
3. Fuel gauge
4. Variable speed lock-on
5. Trigger
6. Handle
7. Air intake vent
8. Tube latch
9. Tube

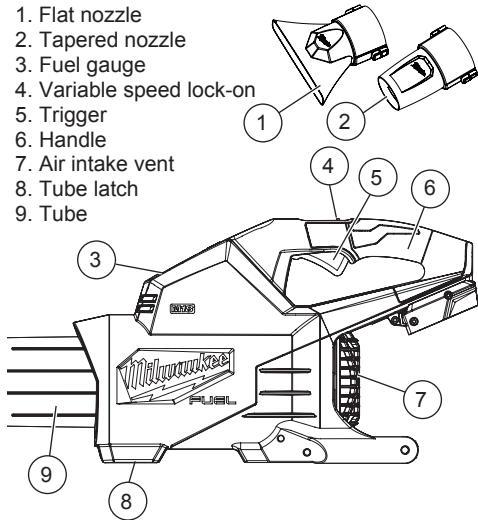

Tube Assembly

WARNING To reduce the risk of injury, do not operate blower without tube securely in place. Never reach into blower through tube hole.

To **install**, line up the tab on the tube with the notch in the housing. Slide the tube into the housing until it snaps in place. Pull on the tube to ensure it is secure.

To **remove** the tube for storage, press the tube latch and pull the tube out of the housing. Always re-install the tube before use.

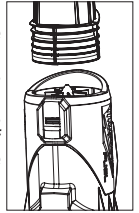

Installing/Removing the Accessories

To **install** the nozzles, line up the tabs on the nozzle with the notches on the tube. Slide the nozzle onto the tube until it snaps in place. Pull on the nozzle to ensure it is secure. To remove, press the tabs in and pull away from the tool.

Fuel Gauge

Use the Fuel Gauge to determine the lowest battery pack's remaining run time. When less than 10% of charge is left, 1 light on the fuel gauge will flash 4 times. When the battery reaches 0% charge, 1 light on the fuel gauge will flash 8 times. Charge the battery packs.

If the Fuel Gauge doesn't appear to be working, place the battery pack on the charger and charge as needed.

Immediately after using the battery pack, the Fuel Gauge may display a lower charge than it will if checked a few minutes later. The battery cells "recover" some of their charge after resting.

SPECIFICATIONS

Cat. No.	M18 F2BL
Volts.....	36V DC
Battery Type.....	M18™
Charger Type.....	M18™
No Load RPM.....	16,750
Max Air Volume.....	17 m ³ /min
Max Air Speed.....	233 km/h
Sound Pressure Level.....	83.0 dB(A)
Recommended Ambient Operating Temperature.....	-17°C to 51°C

ASSEMBLY

WARNING Recharge only with the charger specified for the battery. For specific charging instructions, read the operator's manual supplied with your charger and battery.

Removing/Inserting the Batteries

To remove the batteries, push in the release buttons and pull the battery pack away from the tool.

WARNING Always remove the battery packs any time the tool is not in use.

To insert the batteries, slide the packs into the body of the blower. Make sure they latch securely into place.

NOTICE The blower requires two charged battery packs to operate.

- The blower will not work with only one battery pack.
- If one battery pack is completely discharged, the blower will not function, even if the second battery pack is charged.

•For best results, use with (2) MILWAUKEE® REDLITHIUM™-ION HIGH OUTPUT™ 8.0AH or higher capacity battery packs.

WARNING Only use accessories specifically recommended for this tool. Others may be hazardous.



Fuel Gauge Lights	Diagnosis	Solution
Lights 1 - 4 Solid	Remaining run time	Continue working
1 Light, flashing slowly	Less than 10% run time left	Prepare to charge pack
1 Light, flashing quickly	End of discharge	Charge pack

OPERATION

▲WARNING To reduce the risk of injury, always wear safety goggles or glasses with side shields.

Starting, Stopping and Controlling Speed

▲WARNING Do not point tool at self or bystanders. Keep bystanders 15 m away during use. Objects may be thrown or ricochet in all directions.

The tool can be controlled two ways - by the trigger or by the Variable Speed Lock-On sliding lever.

To **start** the tool, grasp the handle firmly and pull the trigger or push the sliding lever forward.

To **vary** the speed, increase or decrease the pressure on the trigger or move the sliding lever forward or back. The further the trigger is pulled or the sliding lever is pushed, the greater the air flow.

To **lock** on the tool, use the Variable Speed Lock-On sliding lever.

To **stop** the tool, release the trigger or pull back the sliding lever completely.

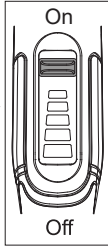

Using the Blower

▲WARNING Inspect the area before using the blower. Remove all debris and hard objects such as rocks, glass, wire, etc. that can ricochet, be thrown, or otherwise cause injury or damage during operation.

Hold the tube 125 mm - 150 mm above the ground. Slowly sweep the blower from side to side. Move forward slowly, working the debris into a pile.

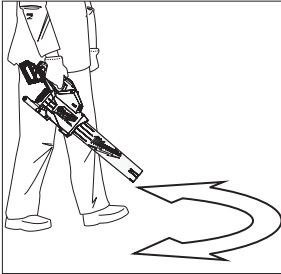

MAINTENANCE

▲WARNING To reduce the risk of injury, always unplug the charger and remove the battery pack from the charger or tool before performing any maintenance. Never disassemble the tool, battery pack or charger. Contact a MILWAUKEE® service facility for ALL repairs.

Maintaining Tool

Keep your tool, battery pack and charger in good repair by adopting a regular maintenance program. Inspect your tool for issues such as undue noise, misalignment or binding of moving parts, breakage of parts, or any other condition that may affect the tool operation. Return the tool, battery pack, and charger to a MILWAUKEE® service facility for repair. After six months to one year, depending on use, return the tool, battery pack and charger to a MILWAUKEE® service facility for inspection.

If the tool does not start or operate at full power with a fully charged battery pack, clean the contacts on the battery pack. If the tool still does not work properly, return the tool, charger and battery pack, to a MILWAUKEE® service facility for repairs.

Cleaning

Clean dust and debris from any vents. Keep tool clean, dry and free of oil or grease. Use only mild soap and a damp cloth to clean, since certain cleaning agents and solvents are harmful to plastics and other insulated parts. Some of these include petrol, turpentine, lacquer thinner, paint thinner, chlorinated cleaning solvents, ammonia and household detergents containing ammonia. Never use flammable or combustible solvents around tools.

Repairs

For repairs, return the tool, battery pack and charger to the nearest authorised service centre.

ACCESSORIES

▲WARNING Use only recommended accessories. Others may be hazardous.

For a complete listing of accessories, go online to milwaukeeetool.com.au / milwaukeeetool.co.nz or contact a distributor.

WARRANTY - AUSTRALIA and NEW ZEALAND

Please refer to Australian and New Zealand warranty supplied with tool. This warranty applies only to product sold by authorised dealers in Australia and New Zealand.

SERVICE - AUSTRALIA and NEW ZEALAND

MILWAUKEE® prides itself in producing a premium quality product that is Nothing But Heavy Duty™. Your satisfaction with our products is very important to us! If you encounter any problems with the operation of this tool, please contact your authorised **MILWAUKEE®** dealer.

For a list of **MILWAUKEE®** dealers, guarantee or service agents please contact **MILWAUKEE®** Customer Service or visit our website.

(Australia Toll Free Telephone Number 1300 645 928)

(New Zealand Toll Free Telephone Number 0800 645 928)

or visit milwaukeetool.com.au/milwaukeetool.co.nz.

Milwaukee Electric Tool Corporation

13135 West Lisbon Road, Brookfield, Wisconsin U.S.A. 53005

Milwaukee Tool (Australia)

26 - 40 Nina Link, Dandenong South,
Victoria, 3175, Australia

Milwaukee Tool (New Zealand)

274 Church Street, Penrose,
Auckland, 1061, New Zealand

DESIGNED BY MILWAUKEE ELECTRIC TOOL CORP.

PROFESSIONALLY MADE IN CHINA

PRINTED IN CHINA