

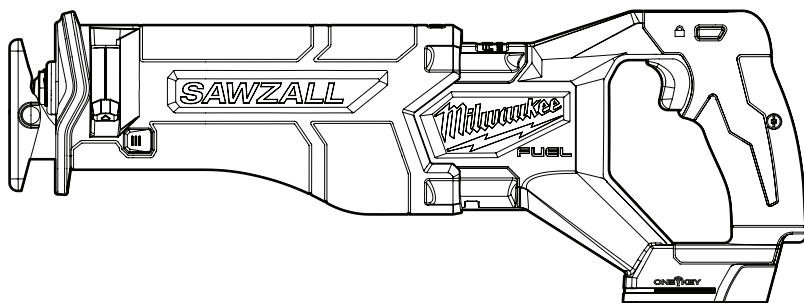

## OPERATOR'S MANUAL



Cat. No.  
**M18 ONESX2**

**M18 FUEL™ ONE-KEY™ SAWZALL™ RECIPROCATING SAW**

 **WARNING**

To reduce the risk of injury, user must read and understand operator's manual.



## GENERAL POWER TOOL SAFETY WARNINGS

**⚠WARNING** Read all safety warnings, instructions, illustrations and specifications provided with this power tool. Failure to follow all instructions listed below may result in electric shock, fire and/or serious injury. **Save all warnings and instructions for future reference.** The term "power tool" in the warnings refers to your mains-operated (corded) power tool or battery-operated (cordless) power tool.

### WORK AREA SAFETY

- **Keep work area clean and well lit.** Cluttered or dark areas invite accidents.
- **Do not operate power tools in explosive atmospheres, such as in the presence of flammable liquids, gases or dust.** Power tools create sparks which may ignite the dust or fumes.
- **Keep children and bystanders away while operating a power tool.** Distractions can cause you to lose control.

### ELECTRICAL SAFETY

- **Power tool plugs must match the outlet. Never modify the plug in any way. Do not use any adapter plugs with earthed (grounded) power tools.** Unmodified plugs and matching outlets will reduce risk of electric shock.
- **Avoid body contact with earthed or grounded surfaces, such as pipes, radiators, ranges and refrigerators.** There is an increased risk of electric shock if your body is earthed or grounded.
- **Do not expose power tools to rain or wet conditions.** Water entering a power tool will increase the risk of electric shock.
- **Do not abuse the cord. Never use the cord for carrying, pulling or unplugging the power tool. Keep cord away from heat, oil, sharp edges or moving parts.** Damaged or entangled cords increase the risk of electric shock.
- **When operating a power tool outdoors, use an extension cord suitable for outdoor use.** Use of a cord suitable for outdoor use reduces the risk of electric shock.
- **If operating a power tool in a damp location is unavoidable, use a residual current device (RCD) protected supply.** Use of a RCD reduces the risk of electric shock.

### PERSONAL SAFETY

- **Stay alert, watch what you are doing and use common sense when operating a power tool. Do not use a power tool while you are tired or under the influence of drugs, alcohol or medication.** A moment of inattention while operating power tools may result in serious personal injury.
- **Use personal protective equipment. Always wear eye protection.** Protective equipment such as a dust mask, non-skid safety shoes, hard hat or hearing protection used for appropriate conditions will reduce personal injuries.
- **Prevent unintentional starting. Ensure the switch is in the off-position before connecting to power source and/or battery pack, picking up or carrying the tool.** Carrying power tools with your finger on the switch or energising power tools that have the switch on invites accidents.

- **Remove any adjusting key or wrench before turning the power tool on.** A wrench or a key left attached to a rotating part of the power tool may result in personal injury.
- **Do not overreach. Keep proper footing and balance at all times.** This enables better control of the power tool in unexpected situations.
- **Dress properly. Do not wear loose clothing or jewellery. Keep your hair and clothing away from moving parts.** Loose clothes, jewellery or long hair can be caught in moving parts.
- **If devices are provided for the connection of dust extraction and collection facilities, ensure these are connected and properly used.** Use of dust collection can reduce dust-related hazards.
- **Do not let familiarity gained from frequent use of tools allow you to become complacent and ignore tool safety principles.** A careless action can cause severe injury within a fraction of a second.

### POWER TOOL USE AND CARE

- **Do not force the power tool. Use the correct power tool for your application.** The correct power tool will do the job better and safer at the rate for which it was designed.
- **Do not use the power tool if the switch does not turn it on and off.** Any power tool that cannot be controlled with the switch is dangerous and must be repaired.
- **Disconnect the plug from the power source and/ or remove the battery pack, if detachable, from the power tool before making any adjustments, changing accessories, or storing power tools.** Such preventive safety measures reduce the risk of starting the power tool accidentally.
- **Store idle power tools out of the reach of children and do not allow persons unfamiliar with the power tool or these instructions to operate the power tool.** Power tools are dangerous in the hands of untrained users.
- **Maintain power tools and accessories. Check for misalignment or binding of moving parts, breakage of parts and any other condition that may affect the power tool's operation. If damaged, have the power tool repaired before use.** Many accidents are caused by poorly maintained power tools.
- **Keep cutting tools sharp and clean.** Properly maintained cutting tools with sharp cutting edges are less likely to bind and are easier to control.
- **Use the power tool, accessories and tool bits etc. in accordance with these instructions, taking into account the working conditions and the work to be performed.** Use of the power tool for operations different from those intended could result in a hazardous situation.
- **Keep handles and grasping surfaces dry, clean and free from oil and grease.** Slippery handles and grasping surfaces do not allow for safe handling and control of the tool in unexpected situations.

### BATTERY TOOL USE AND CARE

- **Recharge only with the charger specified by the manufacturer.** A charger that is suitable for one type of battery pack may create a risk of fire when used with another battery pack.
- **Use power tools only with specifically designated battery packs.** Use of any other battery packs may create a risk of injury and fire.

•When battery pack is not in use, keep it away from other metal objects, like paper clips, coins, keys, nails, screws or other small metal objects, that can make a connection from one terminal to another. Shorting the battery terminals together may cause burns or a fire.

•Under abusive conditions, liquid may be ejected from the battery; avoid contact. If contact accidentally occurs, flush with water. If liquid contacts eyes, additionally seek medical help. Liquid ejected from the battery may cause irritation or burns.

•Do not use a battery pack or tool that is damaged or modified. Damaged or modified batteries may exhibit unpredictable behaviour resulting in fire, explosion or risk of injury.

•Do not expose a battery pack or tool to fire or excessive temperature. Exposure to fire or temperature above 130°C (265°F) may cause explosion.

•Follow all charging instructions and do not charge the battery pack or tool outside the temperature range specified in the instructions. Charging improperly or at temperatures outside the specified range may damage the battery and increase the risk of fire.

### SERVICE

•Have your power tool serviced by a qualified repair person using only identical replacement parts. This will ensure that the safety of the power tool is maintained.

•Never service damaged battery packs. Service of battery packs should only be performed by the manufacturer or authorised service providers.

### SPECIFIC SAFETY RULES FOR SAWZALL™ RECIPROCATING SAW

•Hold the power tool by insulated gripping surfaces, when performing an operation where the cutting accessory may contact hidden wiring. Cutting accessory contacting a “live” wire may make exposed metal parts of the power tool “live” and could give the operator an electric shock.

•Use clamps or another practical way to secure and support the workpiece to a stable platform. Holding the work by hand or against your body leaves it unstable and may lead to loss of control.

•Chemical Burn Hazard. Keep coin cell battery away from children.

**AWARNING** To reduce the risk of injury, when working in dusty situations, wear appropriate respiratory protection or use a suitable dust extraction solution.

•Always use common sense and be cautious when using tools. It is not possible to anticipate every situation that could result in a dangerous outcome. Do not use this tool if you do not understand these operating instructions or you feel the work is beyond your capability; contact MILWAUKEE® Tool or a trained professional for additional information or training.

•Maintain labels and nameplates. These carry important information. If unreadable or missing, contact a MILWAUKEE® service facility for a replacement.

**AWARNING** Some dust created by power sanding, sawing, grinding, drilling, and other construction activities contains chemicals known to cause cancer, birth defects or other reproductive harm. Some examples of these chemicals are:

- lead from lead-based paint
- crystalline silica from bricks and cement and other masonry products, and
- arsenic and chromium from chemically-treated lumber.

Your risk from these exposures varies, depending on how often you do this type of work. To reduce your exposure to these chemicals: work in a well ventilated area, and work with approved safety equipment, such as those dust masks that are specially designed to filter out microscopic particles.

### ADDITIONAL BATTERY SAFETY RULES

**AWARNING** To reduce the risk of fire, personal injury, and product damage due to a short circuit, never immerse your tool, battery pack or charger in fluid or allow a fluid to flow inside them. Corrosive or conductive fluids, such as seawater, certain industrial chemicals, and bleach or bleach-containing products, etc., can cause a short circuit.

### SYMBOLGY



Volts



Direct Current

n, XXXX min<sup>-1</sup> No Load Strokes per Minute (SPM)



Read operator's manual



Do not dispose of electric tools together with household waste material. Electric tools and electronic equipment that have reached the end of their life must be collected separately and returned to an environmentally compatible recycling facility.



Regulatory Compliance Mark (RCM). This product meets applicable regulatory requirements.

### SPECIFICATIONS

Cat. No. ....	M18 ONESX2
Volts.....	18V DC
Battery Type.....	M18™
Charger Type.....	M18™
No Load Strokes per Minute.....	0 - 3000
Length of Stroke.....	32 mm (1-1/4")
Recommended Ambient Operating Temperature.....	-17°C to 51°C

## FUNCTIONAL DESCRIPTION

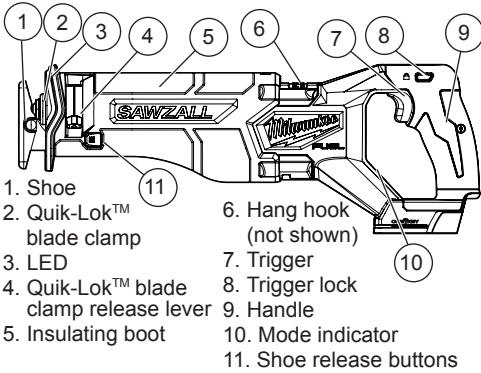

1. Shoe
2. Quik-Lok™ blade clamp
3. LED
4. Quik-Lok™ blade clamp release lever
5. Insulating boot
6. Hang hook (not shown)
7. Trigger
8. Trigger lock
9. Handle
10. Mode indicator
11. Shoe release buttons

## ASSEMBLY

**⚠WARNING** Recharge only with the charger specified for the battery. For specific charging instructions, read the operator's manual supplied with your charger and battery.

### Removing/Inserting the Battery

To remove the battery, push in the release buttons and pull the battery pack away from the tool.

**⚠WARNING** Always remove battery pack before changing or removing accessories.

To insert the battery, slide the pack into the body of the tool. Make sure it latches securely into place.

**⚠WARNING** Only use accessories specifically recommended for this tool. Others may be hazardous.

### Selecting a Blade

The Quik-Lok™ Blade Clamp can be used with all 13 mm (1/2") shank universal SAWZALL™ reciprocating saw blades. Use MILWAUKEE® SAWZALL™ reciprocating saw blades for best performance. When selecting a blade, choose the right type and length. Many types of blades are available for a variety of applications: cutting metal, wood, nail-embedded wood, scroll cutting, roughing-in, and contours.

Many lengths are also available. Choose a length long enough to extend beyond the shoe and the work throughout the stroke. Do not use blades less than 102 mm (4") long since they won't extend beyond the shoe throughout the stroke.

### Installing and Removing Blades from the Quik-Lok™ Blade Clamp

Remove battery pack before changing blades. Make sure the spindle and blade clamp areas are clean. Metal chips and sawdust may prevent the Quik-Lok™ Blade Clamp from clamping securely.

1. Remove battery pack.
2. Depending on the job, the blade may be inserted with the teeth facing up or down. To install a blade, insert the blade into the clamp until the tang butts against the collar.
3. The spring loaded mechanism will clamp the blade firmly in place.
4. Tug on blade to make sure it is securely locked in place.
5. To remove a blade, slide the release lever up and pull the blade from the tool. Be careful when handling hot blades.

## Quik-Lok™ Blade Clamp Maintenance

**⚠WARNING** To reduce the risk of injury, always wear proper eye protection marked to comply with AS/NZS 1337.1.

When working in dusty situations, wear appropriate respiratory protection or use a suitable dust extraction solution.

- Periodically clean dust and debris from the Quik-Lok™ Blade Clamp with dry compressed air.
- If the collar resists, slide the release lever back and forth to shake debris loose.
- Periodically lubricate Quik-Lok™ Blade Clamp with a dry lubricant such as graphite according to the manufacturer's instructions.

### Removing broken blades from the Quik-Lok™ Blade Clamp

Broken blades can be removed by the following methods.

- Remove battery pack before removing blades.
- Point the tool downward, slide up and hold the release lever, and shake the tool up and down (Do not turn the tool on while holding the blade clamp open). The shank of the broken blade should drop out of the clamp.
- If shaking the tool doesn't work...
  - In most cases, a corner of the broken blade will extend beyond the blade clamp. Slide up and hold the release lever, and pull the broken blade out of the clamp by this corner.
  - If the broken stub doesn't extend far enough to be grabbed by its corner, use a thin blade with small teeth (such as a metal cutting blade) to hook the blade that is jammed in the clamp while holding up the release lever, and pull it out.

**⚠WARNING** To reduce the risk of injury, blades must extend beyond the shoe and workpiece throughout the stroke. Blades may shatter if they impact the workpiece or shoe.

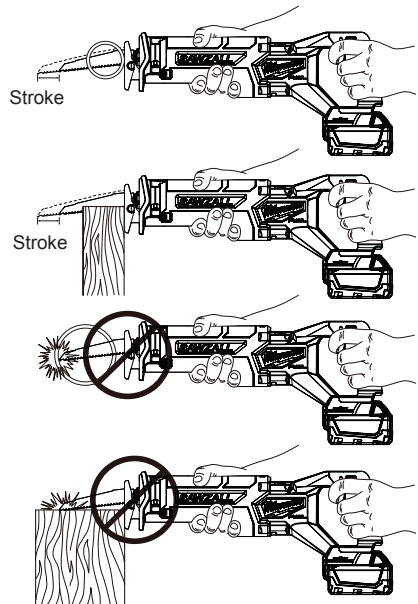

## Adjusting the Pivot Shoe

The shoe can be adjusted forward or backward to eight positions to take advantage of the unused portion of the blade or for special jobs requiring low blade clearance.

- To adjust the shoe, press the shoe release buttons simultaneously and slide the shoe forward or backward to the desired position. Tug on shoe to make sure it is securely locked in place.
- After adjusting the shoe, slowly pull the trigger to be sure the blade always extends beyond the shoe and the workpiece throughout the stroke.

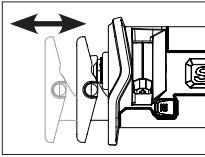
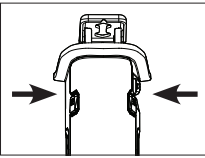

**DO NOT OPERATE SAWZALL™ RECIPROCATING SAW WITHOUT SHOE. STRIKING THE SPINDLE AGAINST WORKPIECE MAY DAMAGE THE TOOL.**

### ONE-KEY™

To learn more about the ONE-KEY™ functionality for this tool, please refer to the quick reference included with this product or go to [onekey.milwaukeeertools.com.au/](http://onekey.milwaukeeertools.com.au/) To download the ONE-KEY™ app, visit the App Store or Google Play from your smart device.

ONE-KEY™ Indicator	
Solid Blue	Wireless mode is active and ready to be configured via the ONE-KEY™ app.
Blinking Blue	Tool is actively communicating with the ONE-KEY™ app.
Blinking Red	Tool is in security lockout and can be unlocked by the owner via the ONE-KEY™ app.

## OPERATION

**WARNING** To reduce the risk of injury, always wear proper eye protection marked to comply with AS/NZS 1337.1.

When working in dusty situations, wear appropriate respiratory protection or use a suitable dust extraction solution.

Always remove battery pack before changing or removing accessories. Only use accessories specifically recommended for this tool. Others may be hazardous.

### Trigger Lock

To **lock**  the trigger, push the trigger lock to the right. The trigger will not work while the switch is in the locked position. Always lock the trigger and remove the battery pack before performing maintenance and changing accessories. Lock the trigger when storing the tool and when the tool is not in use.

To **unlock**  the trigger, push the trigger lock to the left.

## Cut Brake Control

**WARNING** To reduce the risk of electric shock, check work area for hidden pipes and wires before cutting. Generally, the saw blade stops quickly, but there may be a slight delay between the time the cut brake activates and when the blade stops. Always wait for the blade to stop completely before removing the saw from the workpiece and try to avoid contact with sensitive materials.



The Cut Brake detects the load on the tool and stops the blade automatically at the end of a cut. This can help avoid cutting sensitive materials near the workpiece and when working in tight spaces.

When enabled, the Cut Brake Indicator will light solid green. If the Cut Brake activates during a cut, the tool will shut off and the indicator will blink green. To reset, release the trigger.

The Cut Brake may not engage properly when:

- There is excessive vibration during a cut. This can occur when the workpiece is not secured properly, which can cause the cut brake to activate early.
- Pressure on the tool is varied during the cut, which can cause the cut brake to activate early. Keep an even, consistent pressure throughout the cut.
- The trigger is not fully engaged or the tool has not ramped up to full speed. The tool must be running at max speed of the selected mode to engage the cut brake.
- Cutting light materials, such as drywall. If the materials are too thin or light, the tool may not detect a load on the blade and may not shut off when the end of the cut is reached.
- Cutting thin materials, such as 13 mm (1/2") PVC pipe. If the cut time is too short, the tool will not ramp up to full speed and will not shut off when the end of the cut is reached.

### Selecting Mode

Allow the tool to come to a complete stop before changing modes. Press the selector button  to cycle between the modes. Select the ONE-KEY™ indicator  to change the default settings via the ONE-KEY™ App on your smart device.

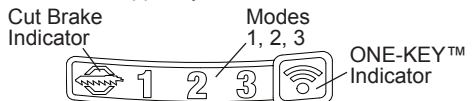

The default settings are shown below and can be changed via the ONE-KEY™ App on your smart device.

	Default Modes		
	Mode 1	Mode 2	Mode 3
Max Speed (SPM)	1300	2300	3000
Cut Brake	Off	Off	Off
Trigger Ramp-up Time*	1 sec.	0.1 sec.	0.1 sec.

\*Trigger Ramp Up is the amount of time it takes for the tool to reach Max Speed. This is beneficial for cutting through dense materials by allowing the blade to bite into the material before increasing in speed, helping make the cut smoother.

**WARNING** To reduce the risk of personal injury, always hold tool securely.

## Starting, Stopping and Controlling Speed

1. To **start** the tool, grasp the handle(s) firmly and pull the trigger.  
**NOTE:** An LED is turned on when the trigger is pulled and will go off shortly after the trigger is released.
2. To **vary** the speed, increase or decrease the pressure on the trigger. The further the trigger is pulled, the greater the speed.
3. To **stop** the tool, release the trigger. Ensure the tool has come to a complete stop before laying the tool down.

## Electric Brake

The electric brake engages when the trigger is released, causing the blade to stop. Generally, the saw blade stops within two seconds. However, there may be a delay between the time the trigger is released and when the brake engages. Occasionally the brake may miss completely. If the brake misses frequently, the saw needs servicing by an authorised **MILWAUKEE®** service facility. Always wait for the blade to stop completely before removing the saw from the workpiece.

## General Cutting

For straight or contour cutting from an edge, line the blade up with the cutting line. Before the blade contacts the workpiece, grasp the handle firmly and pull the trigger. Then guide the tool along the cutting line. Always hold the shoe flat against the workpiece to avoid excessive vibration.

## Cutting Metals

Begin cutting at a slow speed, gradually increasing speed during the cut. When cutting into metals or hard materials that can not be cut from an edge, drill a starting hole larger than the widest part of the blade.

**⚠WARNING** To reduce the risk of explosion, electric shock and property damage, always check the work area for hidden gas pipes, electrical wires or water pipes when making blind or plunge cuts.

## Plunge Cutting

**MILWAUKEE® SAWZALL™** reciprocating saws are ideal for plunge cutting directly into surfaces that can not be cut from an edge, such as walls or floors. Plunge cutting may be done two ways depending on how the blade is inserted. Column A shows how to plunge cut with the teeth of the blade facing downward. Column B shows how to plunge cut with the teeth of the blade facing upward. Do not plunge cut into metal surfaces (see "Cutting Metals").

1. Insert the blade into the tool.  
If blade is inserted with the teeth facing downward, hold the tool as shown in Column A, resting the edge of the shoe on the workpiece.  
If blade is inserted with the teeth facing upward, hold the tool as shown in Column B, resting the edge of the shoe on the workpiece.
2. With the blade just above the workpiece, pull the trigger. Using the edge of the shoe as a pivot, lower the blade into the workpiece as shown.

3. As the blade starts cutting, raise the handle of the tool slowly until the shoe rests firmly on the workpiece. Then guide the tool along the cutting line to acquire the desired cut.

**NOTE:** To make plunge cutting easier, use a heavy gauge blade and install the blade with the teeth facing upward as shown in Column B.

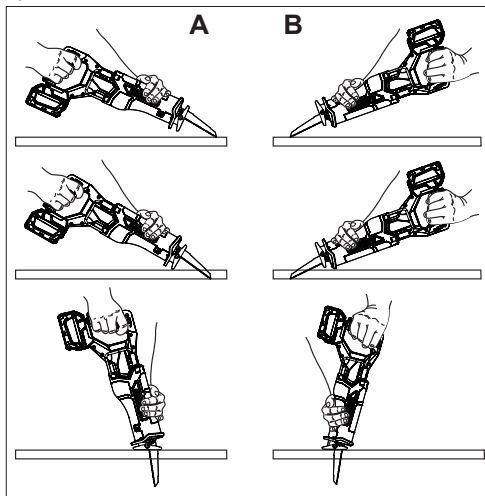

## MAINTENANCE

**⚠WARNING** To reduce the risk of injury, always unplug the charger and remove the battery pack from the charger or tool before performing any maintenance. Never disassemble the tool, battery pack or charger. Contact a **MILWAUKEE®** service facility for ALL repairs.

## Maintaining Tool

Keep your tool, battery pack and charger in good repair by adopting a regular maintenance program. Inspect your tool for issues such as undue noise, misalignment or binding of moving parts, breakage of parts, or any other condition that may affect the tool operation. Return the tool, battery pack, and charger to a **MILWAUKEE®** service facility for repair. After six months to one year, depending on use, return the tool, battery pack and charger to a **MILWAUKEE®** service facility for inspection.

If the tool does not start or operate at full power with a fully charged battery pack, clean the contacts on the battery pack. If the tool still does not work properly, return the tool, charger and battery pack, to a **MILWAUKEE®** service facility for repairs.

## ONE-KEY™

**⚠WARNING** Chemical Burn Hazard. This device contains a lithium button/coin cell battery. A new or used battery can cause severe internal burns and lead to death in as little as 2 hours if swallowed or enters the body. Always secure the battery cover. If it does not close securely, stop using the device, remove the batteries, and keep it away from children. If you think batteries may have been swallowed or entered the body, seek immediate medical attention.



## Internal Battery

An internal battery is used to facilitate full ONE-KEY™ functionality.

If the Mode Indicator LED turns off and the tool cannot adjust speed, or if the Bluetooth communication stops working, remove and reinsert the coin cell battery to reset. Replace the battery if the problem continues.

To replace the battery:

1. Remove the battery pack.
2. Remove the screw(s) and open the battery door.
3. Remove the old battery, keep it away from children, and dispose of it properly.
4. Insert the new battery (3V CR2032), with the positive side facing up.
5. Close the battery door and tighten the screw(s) securely.

**⚠WARNING** To reduce the risk of personal injury and damage, never immerse your tool, battery pack or charger in liquid or allow a liquid to flow inside them.

## Cleaning

Clean dust and debris from vents. Keep handles clean, dry and free of oil or grease. Use only mild soap and a damp cloth to clean, since certain cleaning agents and solvents are harmful to plastics and other insulated parts. Some of these include gasoline, turpentine, lacquer thinner, paint thinner, chlorinated cleaning solvents, ammonia and household detergents containing ammonia. Never use flammable or combustible solvents around tools.

## Repairs

For repairs, return the tool, battery pack and charger to the nearest authorised service centre.

## ACCESSORIES

**⚠WARNING** Use only recommended accessories. Others may be hazardous.

For a complete listing of accessories, go online to [milwaukeeetool.com.au/](http://milwaukeeetool.com.au/) [milwaukeeetool.co.nz](http://milwaukeeetool.co.nz) or contact a distributor.

## **WARRANTY - AUSTRALIA and NEW ZEALAND**

Please refer to Australian and New Zealand warranty supplied with tool. This warranty applies only to product sold by authorised dealers in Australia and New Zealand.

## **SERVICE - AUSTRALIA and NEW ZEALAND**

**MILWAUKEE®** prides itself in producing a premium quality product that is Nothing But Heavy Duty™. Your satisfaction with our products is very important to us! If you encounter any problems with the operation of this tool, please contact your authorised **MILWAUKEE®** dealer.

For a list of **MILWAUKEE®** dealers, guarantee or service agents please contact **MILWAUKEE®** Customer Service or visit our website.

(Australia Toll Free Telephone Number 1300 645 928)

(New Zealand Toll Free Telephone Number 0800 645 928)

or visit [milwaukeeetool.com.au/milwaukeeetool.co.nz](http://milwaukeeetool.com.au/milwaukeeetool.co.nz).

### **Milwaukee Electric Tool Corporation**

13135 West Lisbon Road, Brookfield, Wisconsin U.S.A. 53005

### **Milwaukee Tool (Australia)**

21 Kelletts Road, Rowville, VIC 3178  
Melbourne, Australia

### **Milwaukee Tool (New Zealand)**

274 Church Street, Penrose,  
Auckland, 1061, New Zealand

DESIGNED BY MILWAUKEE ELECTRIC TOOL CORP.  
PROFESSIONALLY MADE IN CHINA  
PRINTED IN CHINA