

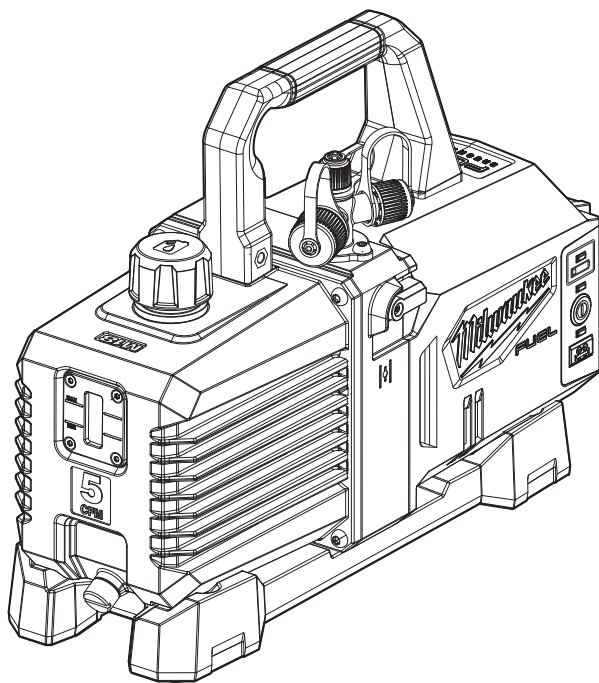



OPERATOR'S MANUAL



Cat. No.
M18 FVP5

M18 FUEL™ 5 CFM VACUUM PUMP

 **WARNING**

 To reduce the risk of injury, user must read and understand operator's manual.

GENERAL PUMP SAFETY WARNINGS

WARNING Read all safety warnings, instructions, illustrations and specifications provided with this pump. Failure to follow all instructions listed below may result in electric shock, fire and/or serious injury. Save all warnings and instructions for future reference.

WORK AREA SAFETY

- **Keep work area clean and well lit.** Cluttered or dark areas invite accidents.
- **Do not operate pump in explosive atmospheres,** such as in the presence of flammable liquids, gases or dust.
- **Keep children and bystanders away while operating a pump.** Distractions can cause you to lose control.

ELECTRICAL SAFETY

- **Power tool plugs must match the outlet. Never modify the plug in any way. Do not use any adapter plugs with earthed (grounded) power tools.** Unmodified plugs and matching outlets will reduce risk of electric shock.
- **Avoid body contact with earthed or grounded surfaces, such as pipes, radiators, ranges and refrigerators.** There is an increased risk of electric shock if your body is earthed or grounded.
- **Do not expose pump to rain or wet conditions.** Water entering a power tool will increase the risk of electric shock.
- **Do not abuse the cord. Never use the cord for carrying, pulling or unplugging the power tool. Keep cord away from heat, oil, sharp edges or moving parts.** Damaged or entangled cords increase the risk of electric shock.
- **When operating a pump outdoors, use an extension cord suitable for outdoor use.** Use of a cord suitable for outdoor use reduces the risk of electric shock.

PERSONAL SAFETY

- **Stay alert, watch what you are doing and use common sense when operating pump. Do not use pump while you are tired or under the influence of drugs, alcohol or medication.** A moment of inattention while operating may result in serious personal injury.
- **Use personal protective equipment. Always wear eye protection.** Protective equipment such as a dust mask, non-skid safety shoes, hard hat or hearing protection used for appropriate conditions will reduce personal injuries.
- **Do not overreach. Keep proper footing and balance at all times.** This enables better control of the pump in unexpected situations.
- **Dress properly. Do not wear loose clothing or jewellery. Keep your hair and clothing away from moving parts.** Loose clothes, jewellery or long hair can be caught in moving parts.
- **Do not let familiarity gained from frequent use of pump allow you to become complacent and ignore pump safety principles.** A careless action can cause severe injury within a fraction of a second.

PUMP USE AND CARE

- **Do not force the pump. Use the correct pump for your application.** The correct pump will do the job better and safer at the rate for which it was designed.
- **Remove the battery pack from the pump before making any adjustments, changing accessories, or storing.** Such preventive safety measures reduce the risk of starting the pump accidentally.
- **Store idle pump out of the reach of children and do not allow persons unfamiliar with the pump or these instructions to operate the pump.** Pumps are dangerous in the hands of untrained users.
- **Maintain pump and accessories. Check for misalignment or binding of moving parts, breakage of parts and any other condition that may affect the pump's operation. If damaged, have the pump repaired before use.** Many accidents are caused by poorly maintained pumps.
- **Use the pump, accessories and etc. in accordance with these instructions, taking into account the working conditions and the work to be performed.** Use of the pump for operations different from those intended could result in a hazardous situation.
- **Keep handles and grasping surfaces dry, clean and free from oil and grease.** Slippery handles and grasping surfaces do not allow for safe handling and control of the pump in unexpected situations.

BATTERY USE AND CARE

- **Recharge only with the charger specified by the manufacturer.** A charger that is suitable for one type of battery pack may create a risk of fire when used with another battery pack.
- **Use pump only with specifically designated battery packs.** Use of any other battery packs may create a risk of injury and fire.
- **When battery pack is not in use, keep it away from other metal objects, like paper clips, coins, keys, nails, screws or other small metal objects, that can make a connection from one terminal to another.** Shorting the battery terminals together may cause burns or a fire.
- **Under abusive conditions, liquid may be ejected from the battery; avoid contact. If contact accidentally occurs, flush with water. If liquid contacts eyes, additionally seek medical help.** Liquid ejected from the battery may cause irritation or burns.
- **Do not use a battery pack or pump that is damaged or modified.** Damaged or modified batteries may exhibit unpredictable behavior resulting in fire, explosion or risk of injury.
- **Do not expose a battery pack or pump to fire or excessive temperature.** Exposure to fire or temperature above 130°C (265°F) may cause explosion.
- **Follow all charging instructions and do not charge the battery pack or pump outside the temperature range specified in the instructions.** Charging improperly or at temperatures outside the specified range may damage the battery and increase the risk of fire.

SERVICE

- **Have your pump serviced by a qualified repair person using only identical replacement parts.** This will ensure that the safety of the pump is maintained.
- **Never service damaged battery packs.** Service of battery packs should only be performed by the manufacturer or authorised service providers.

SPECIFIC SAFETY RULES FOR VACUUM PUMPS

- **WARNING** This pump generates a deep vacuum that can be harmful to human tissue. Do not expose any part of the human body to the vacuum.
- **Add oil before initial use. Do not operate pump without oil.**
- **Use oil specifically refined for deep vacuum pumps.**
- **Avoid contact on skin and clothing with oil.**
- **After evacuation, drain oil immediately while pump is warm. Dispose of used oil properly.**
- **The MILWAUKEE® M18 FUEL™ 5 CFM Vacuum Pump is suitable for use with systems that utilise A2L refrigerants provided proper precautions have been followed. This includes ensuring all refrigerant has been removed when servicing or evacuating a system that contains A2L refrigerants. Due to the mildly flammable nature of A2L refrigerants, it is important to ensure users receive proper technical training prior to handling these refrigerants. Special licensing or certification may be required before handling flammable refrigerants. Always follow local, state and/or federal regulations or guidelines when working on systems containing refrigerants.**

- **WARNING** Some dust created by power sanding, sawing, grinding, drilling, and other construction activities contains chemicals known to cause cancer, birth defects or other reproductive harm. Some examples of these chemicals are:
 - lead from lead-based paint
 - crystalline silica from bricks and cement and other masonry products, and
 - arsenic and chromium from chemically-treated lumber.

Your risk from these exposures varies, depending on how often you do this type of work. To reduce your exposure to these chemicals: work in a well ventilated area, and work with approved safety equipment, such as those dust masks that are specially designed to filter out microscopic particles.









- **Always use common sense and be cautious when using tools.** It is not possible to anticipate every situation that could result in a dangerous outcome. Do not use this tool if you do not understand these operating instructions or you feel the work is beyond your capability; contact MILWAUKEE® Tool or a trained professional for additional information or training.
- **Maintain labels and nameplates. These carry important information.** If unreadable or missing, contact a MILWAUKEE® service facility for a replacement.

ADDITIONAL BATTERY SAFETY RULES

WARNING To reduce the risk of fire, personal injury, and product damage due to a short circuit, never immerse your tool, battery pack or charger in fluid or allow a fluid to flow inside them. Corrosive or conductive fluids, such as seawater, certain industrial chemicals, and bleach or bleach-containing products, etc., can cause a short circuit.

WARNING Do not charge non-rechargeable batteries.

SYMBOLGY

	Volts
	Direct Current
	Low battery
	Power On/Off
	Manifold Mode On/Off
	Valve open
	Oil Fill
CFM	Cubic Feet per Minute
	Read Operator's Manual
	Regulatory Compliance Mark (RCM). This product meets applicable regulatory requirements.

Do not dispose of electric tools together with household waste material. Electric tools and electronic equipment that have reached the end of their life must be collected separately and returned to an environmentally compatible recycling facility.



FUNCTIONAL DESCRIPTION

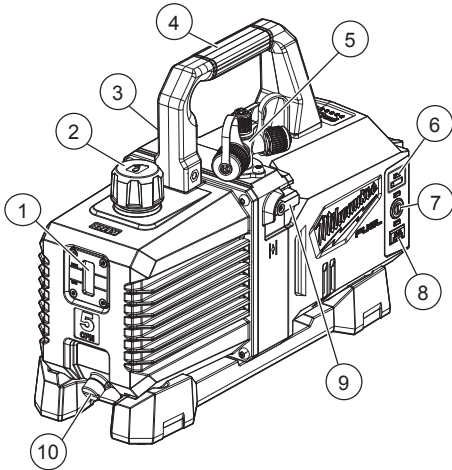

- | | |
|----------------------|--------------------------|
| 1. Oil level window | 6. Low battery indicator |
| 2. Oil fill cap | 7. ON/OFF Button |
| 3. Gas ballast valve | 8. Manifold mode button |
| 4. Carry handle | 9. Isolation valve |
| 5. Intake fittings | 10. Oil drain |

SPECIFICATIONS

Cat. No.	M18 FVP5
Volts	18 V DC
Battery Type	M18™
Charger Type	M18™
Flow Rate	141 L/MIN (5 CFM)
Ultimate Vacuum	25 Microns
Intake Ports	1/2", 3/8", 1/4"
Oil Capacity	550 ml (18.6 oz)
Weight (Tool-Only)	8.6kg (19 lbs)
Recommended Ambient Operating Temperature	-17°C to 51° C (0°F to 125°F)

ASSEMBLY

⚠WARNING Recharge only with the charger specified for the battery. For specific charging instructions, read the operator's manual supplied with your charger and battery.

Inserting/ Removing the Battery

To **insert** the battery, slide the pack into the body of the tool. Make sure it latches securely into place.

To **remove** the battery, push in the release buttons and pull the battery pack away from the tool.

⚠WARNING Always remove the battery pack any time the tool is not in use.

⚠WARNING Only use accessories specifically recommended for this tool. Others may be hazardous.

Priming the Pump and Adding Oil

⚠WARNING The pump is shipped without oil and must be primed for initial use.

To ready the pump for first time use, either:

- Add oil and run the pump for 30 minutes. Change the oil (or let the oil cool down before beginning work).
- Add oil and wait 1 hour before beginning work.

Adding Oil

⚠WARNING Do not operate pump without oil. Only use oil specifically refined for deep vacuum pumps.

To add oil:

1. Twist open the oil fill cap.
2. Slowly add oil into the oil reservoir until level is between the MIN and MAX markings.
3. Replace oil fill cap.
4. Monitor oil level during use.

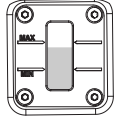

Isolation valve

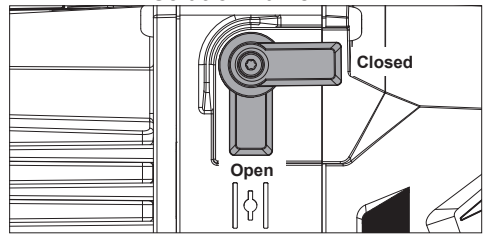

Manifold mode

When using a manifold, turn **ON** Manifold mode for best performance. When using a manifold, a 4-port manifold is recommended.

Low Battery mode

When battery capacity reaches 5 minutes of runtime remaining, the pump will enter low battery mode. The Low Battery LED will light and a buzzer will sound. The pump will reduce in speed to conserve runtime and maintain vacuum. Replace battery.

Thermal Overload

If Power button LED begins blinking, the tool has entered thermal overload protection and cannot be restarted until the pump has cooled down.

Cold mode

When used in environments under 20 degrees Celsius, the pump will reduce the initial operating speed to warm up the oil and motor for optimal performance. Pump will return to normal speed automatically.

Selecting Hoses

For best performance, use vacuum rated hoses directly connected to the pump that are as short and of the widest diameter possible. Inspect hoses before operation and replace if worn.

OPERATION

⚠WARNING To reduce the risk of injury, always wear proper eye protection marked to comply with AS/NZS 1337.1.

General operation

1. Insert battery pack.
2. Check oil level.
3. Open the gas ballast valve.
4. Make hose connections to the pump either directly or using a manifold. Make vacuum connections.
5. Open one intake port and the isolation valve, close gas ballast valve, and turn pump ON.
6. Slowly open the gas ballast valve at the beginning of the evacuation process.
7. After pump settles down from initial volume of air, close ballast valve and continue evacuating.
8. When finished, close the isolation valve and fully open the gas ballast valve.
9. Operate the pump for 2-3 more seconds, then turn OFF the pump and close the isolation valve.
10. Remove hose connections and cap the intake fittings.

MAINTENANCE

⚠WARNING To reduce the risk of injury, always unplug the charger and remove the battery pack from the charger or tool before performing any maintenance. Never disassemble the tool, battery pack or charger. Contact a **MILWAUKEE®** service facility for ALL repairs.

Changing Oil

After each use while pump is warm and oil is thinner, place pump on level surface and open oil drain. Oil can be forced from the pump by opening one intake and partially blocking the exhaust with a cloth then running the pump. DO NOT operate the pump for more than 20 seconds using this method. Dispose of used oil properly.

Flushing Oil

If the oil is severely contaminated, flushing may be required. With the oil drain open, slowly add oil into the reservoir while pump is running until contamination is removed. Dispose of flushed oil properly.

Maintaining Tool

Keep your tool, battery pack and charger in good repair by adopting a regular maintenance program. Inspect your tool for issues such as undue noise, misalignment or binding of moving parts, breakage of parts, or any other condition that may affect the tool operation. Return the tool, battery pack, and charger to a **MILWAUKEE®** service facility for repair. After six months to one year, depending on use, return the tool, battery pack and charger to a **MILWAUKEE®** service facility for inspection. If the tool does not start or operate at full power with a fully charged battery pack, clean the contacts on the battery pack. If the tool still does not work properly, return the tool, charger and battery pack, to a **MILWAUKEE®** service facility for repairs.

Cleaning

Clean dust and debris from any vents. Keep tool clean, dry and free of oil or grease. Use only mild soap and a damp cloth to clean, since certain cleaning agents and solvents are harmful to plastics and other insulated parts. Some of these include petrol, turpentine, lacquer thinner, paint thinner, chlorinated cleaning solvents, ammonia and household detergents containing ammonia. Never use flammable or combustible solvents around tools.

Repairs

For repairs, return the tool, battery pack and charger to the nearest authorised service centre.

ACCESSORIES

⚠WARNING Use only recommended accessories. Others may be hazardous.

For a complete listing of accessories, go online to milwaukeeetool.com.au / milwaukeeetool.co.nz or contact a distributor.

WARRANTY - AUSTRALIA and NEW ZEALAND

Please refer to Australian and New Zealand warranty supplied with tool. This warranty applies only to product sold by authorised dealers in Australia and New Zealand.

SERVICE - AUSTRALIA and NEW ZEALAND

MILWAUKEE® prides itself in producing a premium quality product that is Nothing But Heavy Duty™. Your satisfaction with our products is very important to us! If you encounter any problems with the operation of this tool, please contact your authorised **MILWAUKEE®** dealer.

For a list of **MILWAUKEE®** dealers, guarantee or service agents please contact **MILWAUKEE®** Customer Service or visit our website.

(Australia Toll Free Telephone Number 1300 645 928)

(New Zealand Toll Free Telephone Number 0800 645 928)

or visit milwaukeetool.com.au/milwaukeetool.co.nz.

Milwaukee Electric Tool Corporation

13135 West Lisbon Road, Brookfield, Wisconsin U.S.A. 53005

Milwaukee Tool (Australia)

26 - 40 Nina Link, Dandenong South,
Victoria, 3175, Australia

Milwaukee Tool (New Zealand)

274 Church Street, Penrose,
Auckland, 1061, New Zealand

DESIGNED BY MILWAUKEE ELECTRIC TOOL CORP.